

CE  
0086



**Prestige Medical**  
Integrated Decontamination Solutions

# Instructions for use



**Advance Pro**

# Instructions for use

Please read these instructions before using the autoclave.

Keep these "Instructions for use" in a safe place close by the unit for future reference.

UK Customer care line: 01254 844 116

e-mail: [customerservice@prestigemedical.co.uk](mailto:customerservice@prestigemedical.co.uk)

The Prestige Medical Customer Service Team is available to provide advice and assistance during normal office hours. To avoid delays when making contact, please have the unit's Model and Serial Numbers at hand.

For additional information visit [www.prestigemedical.co.uk](http://www.prestigemedical.co.uk)

UK Customers

Prestige Medical Limited  
East House, Duttons Way,  
Shadsworth Business Park,  
Blackburn BB1 2QR

Overseas Customers

Contact your local distributor. In case of doubt contact Prestige Medical Ltd

Tel : +44 (0) 1254 682 622  
Fax : +44 (0) 1254 682 606

[www.prestigemedical.co.uk](http://www.prestigemedical.co.uk)  
[sales@prestigemedical.co.uk](mailto:sales@prestigemedical.co.uk)



**Prestige Medical**  
Integrated Decontamination Solutions



ISO 13485 2016  
Cert No. FM79156

Model

Rating plate

Serial Number.

Date of purchase: ...../...../.....

Prestige Medical Limited

East House, Duttons Way, Shadsworth Business Park, Blackburn, BB1 2QR

Tel : +44 (0) 1254 682 622 - Fax : +44 (0) 1254 682 606

[www.prestigemedical.co.uk](http://www.prestigemedical.co.uk) - [sales@prestigemedical.co.uk](mailto:sales@prestigemedical.co.uk)

Registered in England

Reg No. 2826793

# Contents

Section		Page
1	Introduction	1
2	General / Safety Recommendations	2
3	Unit Description	3
4	Installation	5
5	Features	6
6	Rating plate & serial number	9
7	Cycle and Load Type	10
8	Getting Started	11
9	Delayed cycle start	15
10	Time settings	15
11	Data recording	16
12	Essential information	17
13	Warranty	17
14	Cleaning & routine maintenance	18
15	Direct feed & rapid drain system	22
16	Bowie Dick test	23
17	Helix Test	24
18	Specification	25
19	Additional Information	26
20	Loading	27
21	Emergency Door Release	28
22	Recovery Sequence	29
23	Manual stop	29
24	Trouble Shooting	30
25	Cycle Profiles	31
26	Leak Test	34
27	Water Quality	35
28	Accessories & Consumables	36

Please read these instructions carefully before using the autoclave.

## Section 1: Introduction

Thank you for choosing the Prestige Medical Advance Pro Autoclave. This machine is fitted with sophisticated control software and will automatically adjust the cycle time dependent on the mass of load to be sterilised. This will ensure the optimum sterilizing and drying conditions for all loads. All “Type B” vacuum cycles use the triple pulse fractionated vacuum system. Non-vacuum cycles use the thermodynamic air displacement system. Vacuum Drying cycles employ a “closed door” system. Before unpacking, refer to the section 2 on page 2 and whilst unpacking check the unit for transit damage. If damage is found, please report this to the shipping agent immediately, in writing, and then notify your dealer.

Product contents comprise of the following:

- Autoclave with internal furniture.
- Instructions for Use and warranty card.
- Performance Test Certificate and Certificate of Conformance for pressure vessel (all UK models).
- Installation sheet.
- Written Scheme of Examination (UK models).

All Customers, when you receive your Advance Pro autoclave ensure that you complete and return your Warranty Registration Card.

### Types of load and loading.

Advance Pro autoclaves are designed to sterilize instruments, utensils and other items as defined by EN13060. Advance Pro Class B vacuum autoclaves are suitable for the sterilization of solid, hollow, unwrapped and pouched instruments as well as textile loads. The autoclaves operate automatically with 134oC and 121oC sterilizing temperatures (with or without drying). A full list of sterilization cycles and times is shown in Section 25.



#### **WARNING!**

Refer to the instrument manufacturer to ensure the instruments suitability for autoclaving and the maximum temperature they can withstand.

A “responsible person” must qualify other loads as suitable. Refer to “Additional Information” in Section 18. Refer to “Specification”, Section 15, for the maximum instrument load for the autoclave. All instruments must be cleaned appropriately prior to sterilizing. Wrapped or pouched loads should not touch adjacent loads. Pouches must be used for one item only. When placing items on a pouch tray, ensure they are placed so that they do not touch each other and that the load does not touch other trays or the chamber in any way. Always use the lifting device when removing pouch trays from the autoclave as they may be hot. Long trays should be supported at their rear as they become free of the tray carrier.



#### **WARNING!**

Failing to observe the instructions as specified in this manual can lead to unsafe operation for the user.

## Section 2: General / Safety Recommendations

The user is responsible for the installation, the correct use and maintenance of the sterilizer in accordance with the instructions listed in this manual. For further information please call your local service provider.

- The sterilizer has not been designed for the sterilization of liquids.
- The sterilizer must not be used in the presence of gas or explosive vapours.
- The chamber is automatically heated to 120°C as soon as the sterilizer is switched on.
- The trays and the sterilization load will be hot at the end of each cycle. Use the supplied pouch tray handle to empty the sterilization chamber.
- Do not exceed the maximum load weight limits as specified in this manual (see section 15)
- Do not remove the name plate or any label from the sterilizer.
- To avoid electrical short circuits, do not pour water or any other liquid over the sterilizer.
- Switch off the sterilizer and unplug the mains cable before inspecting, carrying out maintenance or servicing the sterilizer.
- Repairs, maintenance or service must be carried out by authorized Prestige Medical service technicians only with the use of original spare parts.
- In case of transport:
  - Drain both water tanks completely (see section 8).
  - Allow the sterilization chamber to cool down.
  - Use original or appropriate packaging.

### Symbols displayed on the sterilizer

Consult the information given below whenever you see one of these symbols in this manual or on the sterilizer.



**ATTENTION:** where this symbol is displayed on the sterilizer, the user must refer to this document. When shown in the user manual this symbol means ATTENTION IMPORTANT NOTES. To disregard the instructions given in this manual, incorrect use, poor maintenance or servicing by unauthorized personnel clears the manufacturer of any responsibility for warranty and any other claims.



**HOT SURFACES** This symbol is displayed at the front of the sterilizer beneath the chamber door as well as on the top of the unit where the door opens. It reminds the user to take special care to avoid burns when dealing with the sterilization load, the sterilization chamber, the chamber door and the area around the chamber door.



Do not use tap water for acceptable water quality refer to Section 26

### Unpacking the sterilizer

The sterilizer must be removed from the box and transported by two people.

Total weight: Advance Pro 16ltr 39.5 kg, Advance Pro 22ltr 43 kg

Check the external condition of the box and the sterilizer. In case of any damage, immediately contact your dealer or the shipping agent that has carried out the transport

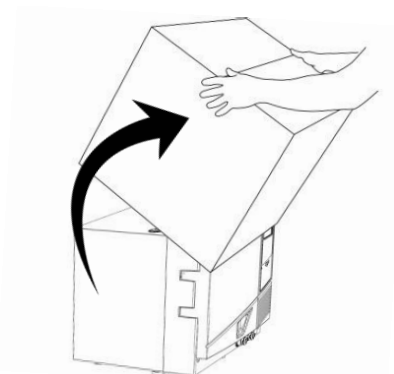

#### **WARNING!**

The autoclave is VERY heavy; a minimum of two people are required to safely lift the unit.

# Section 3: Unit Description

Remote vessel pressure release point

Manual door release location



Control panel

Memory card slot

Cooling duct grille

**WARNING!  
DO NOT COVER OR  
OBSTRUCT**

Main power switch

Visual System Indicator

FlexiRack system

Fresh Water fill point



Door gasket

Fresh water tank drain point. (Quick-disconnect)

Waste water tank drain point (Quick-disconnect)

Air filter

## Section 3: Unit Description continued

Rear view of autoclave (16L model shown)



# Section 4: Installation

The sterilizer has been calibrated and intensively tested prior to shipping. It does not require any calibration during installation. Observe the following environmental conditions: Working temperature range: from +5°C to +40°C / relative humidity: 0 - 90%. Storage temperature range: from -20°C to +60°C / relative humidity: 0 - 90% (empty tanks). Install the sterilizer as outlined below:

If the sterilizer had been kept in a place with temperature and humidity different from the installation location, wait for an appropriate time before installing and switching ON the sterilizer. Sterilizers arriving from cold locations could contain moisture affecting the electrical parts and it could lead to unsafe operation for the user if switched ON immediately.

## 1. Installation.

Ensure the unit is placed on a strong, flat, level and heat resistant surface. If the installation surface is uneven or not level adjust the feet so that the unit is level when viewed from the front, but angled slightly backward when viewed from the side (see illustration).

To check that the unit is set up correctly, pour half a cup of deionised water into the chamber. The water should flow towards the hole at the rear of the chamber, not out of the front. If this happens, readjust the feet.

Leave a gap of 50mm at the back and 20mm on each side of the sterilizer to ensure adequate ventilation.

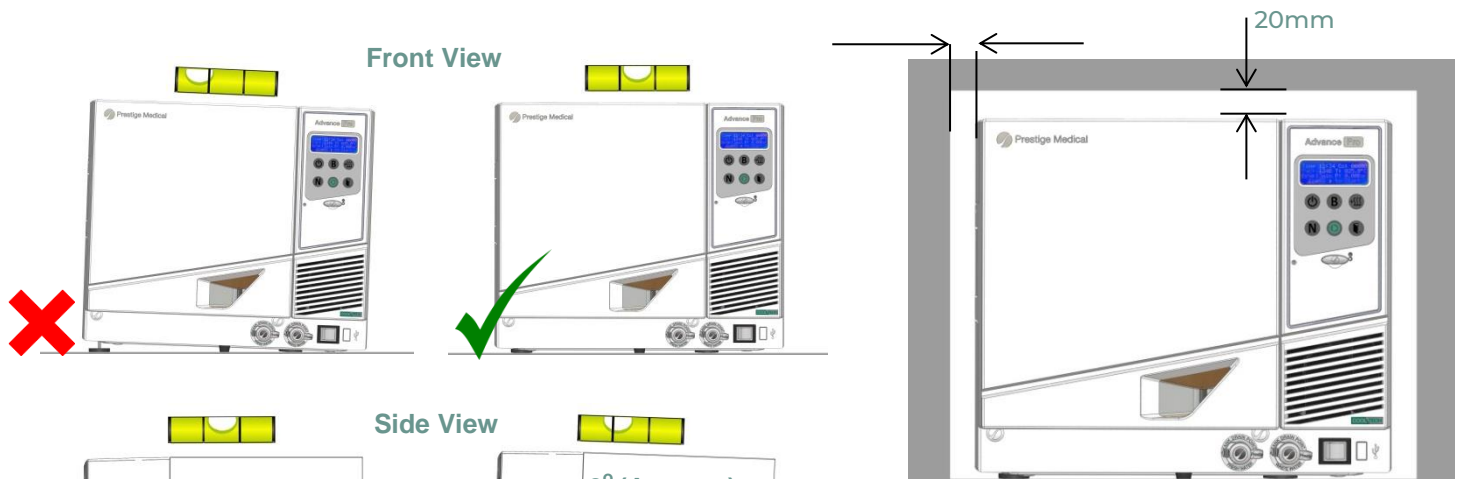

**WARNING!**  
Do not place the sterilizer near a sink or in a location where it is likely to be splashed with water - danger of electric short circuit! Install the sterilizer in a well-ventilated room. Keep the sterilizer away from all sources of heat.

**TOP TIP!**  
Prestige Medical recommends the use of a smart phone spirit level app to aid the positioning of the autoclave as illustrated above.



## 2. Connection & Electrical supply

Plug the unit into the mains outlet socket of the correct type & rating. See the rating plate located on the rear of the machine. Push the on/off switch on the front of the unit. After a few seconds the LED illuminates and the internal heater operates to control the internal temperature at a set value. The electrical power supply to the sterilizer must comply with all applicable standards in the country of use. The following characteristics are required: - Single - phase 200 - 240 VAC ±10%, 50/60 Hz, 10 A.

Maximum power consumption for the Advance Pro is 2,200W (10 A)

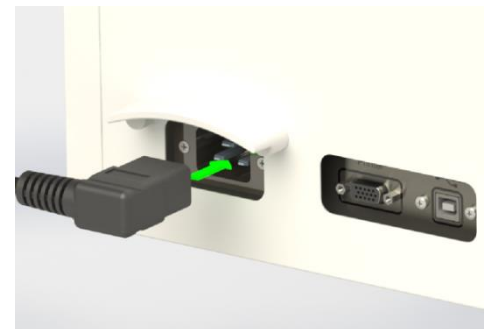

**WARNING!**  
The mains outlet **MUST BE EARTHED (GROUNDED)**. The mains plug should always be easily accessible as it is to be relied upon as "the means of disconnection".



## Section 5: Features

# HTS<sup>®</sup>

The HeatTransfer System<sup>®</sup> has been designed and developed to take full advantage of the high performance thermal conductivity properties of aluminium. The innovative FlexiRack<sup>®</sup> system transfers heat from the internal vessel mounted heating unit and transfers this via thermal conductivity directly to the load placed onto the FlexiRack<sup>®</sup> rails.

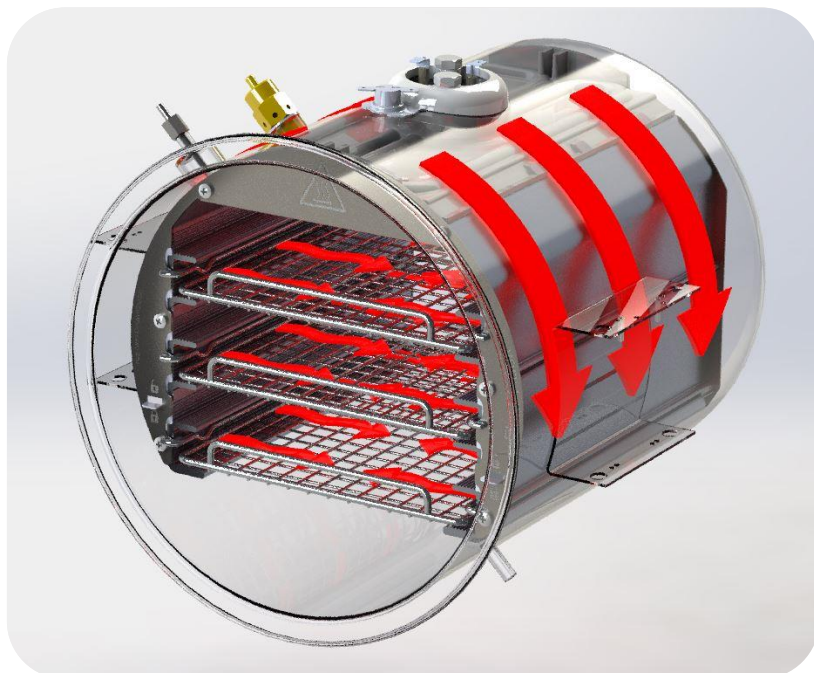

This new HeatTransfer System<sup>®</sup> heats the chamber and load in a quick and even manner, without resorting to complex electronic devices, steam injection or high powered heating elements.

## COOL TECH

The Advance Pro utilises the latest in compact high performance cooling radiators to aid in reducing the overall cycle time. The Advance Pro takes advantage of having two independent cooling systems mounted in one compact assembly; One section is used for the vacuum stage of the cycle whereas the secondary section is used solely to condense the waste high pressure steam into water before it reaches the waste tank.

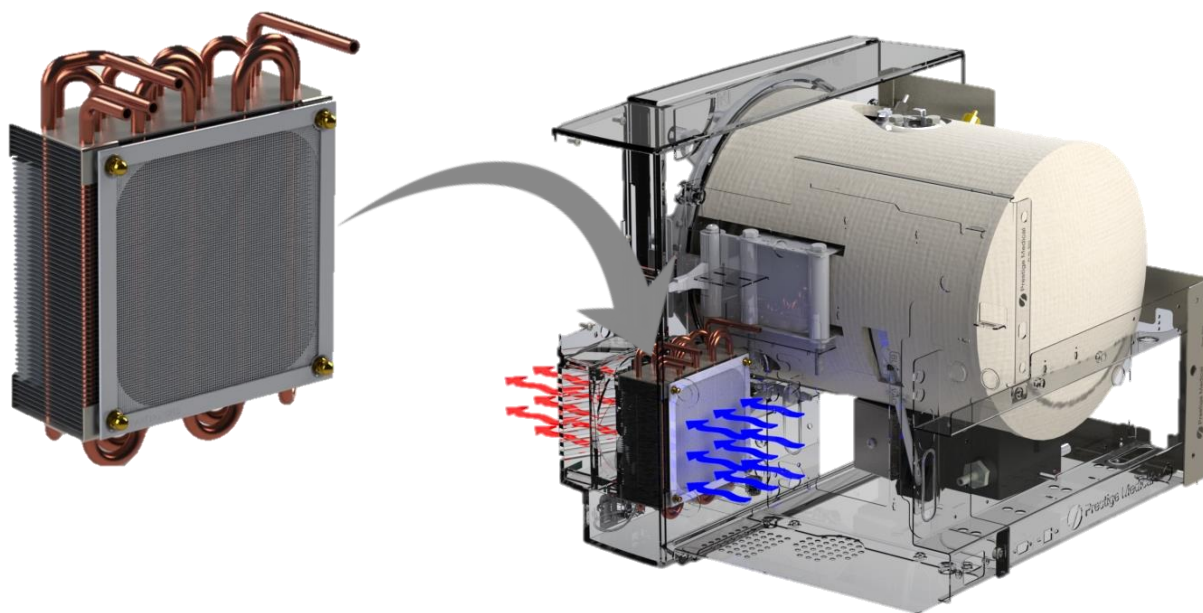

## Section 5: Features *continued*

### **Flexi** Rack

The Prestige Medical FlexiRack® system is a user configurable racking system unique within the small benchtop autoclave sector. The high quality extruded aluminium rack supports 12 individual support rails onto which the loads are placed directly.

The FlexiRack® can be configured in up to 20 different configurations; the maximum number of individual tray loading points is six. Your Advance Pro is supplied with 6 individual stainless wire mesh pouch trays which have been specifically designed and developed to work with the FlexiRack® system. When using alternative pouch trays and other sterilizing storage products please ensure they fit securely and are not physically forced into the racking system.

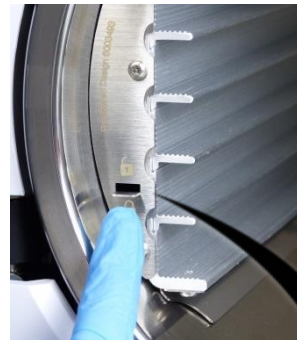

To reconfigure the rail positions simply push the locking tab upwards (as shown in the image left) and slide the rails out of the rack. When sliding the rails out always push them into the rack guides and slide out. This reduces the friction between the two parts.

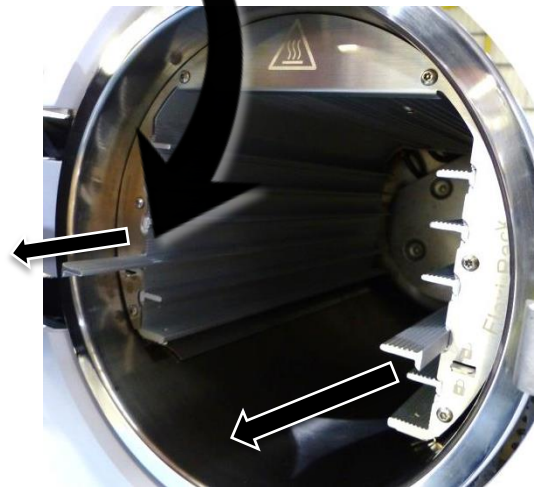

Caution Hot! Take care when removing the FlexiRack rails after the machine has either been switched on or after a cycle.

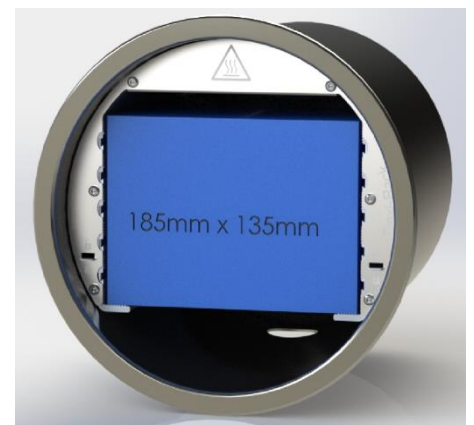
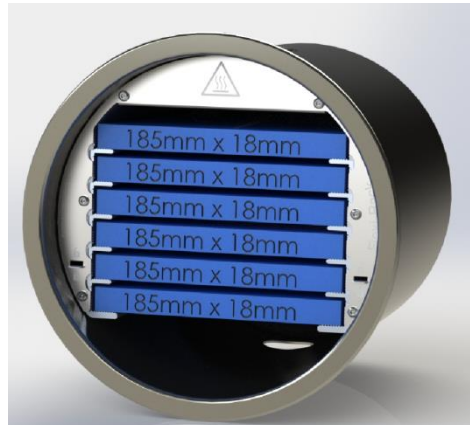
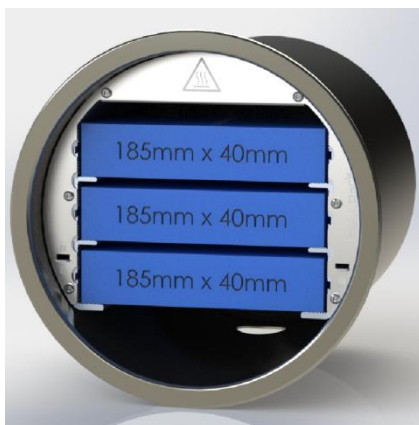

The three images above are examples of how the FlexiRack system can be configured to accept varying sizes and shapes of loads. Please always refer to the machine specifications page (page 24 section 15) to check your maximum capacities and loading techniques. Always verify the cycle using a secondary process challenge device.



**WARNING!**  
Never overload the Autoclave

## Section 5: Features *continued*

### Internal water tanks

The Prestige Medical Advance Pro is equipped with two internal water tanks, one for fresh and the other for waste water. The composite colour coded fresh water tank is located in the upper part of the machine and the waste tank is located in the base of the machine so that waste heat can be quickly dissipated through vents located in the lower area of the machine.

The Advance Pro is unique within the small autoclave sector in that it utilises a high quality fully welded stainless steel tank to store the waste water. This enables the tank to withstand the extreme temperatures and the possible presence of oil that can eventually cause plastic tanks to fail. The fresh water tank filling spout is located behind the main door and has a low water level sensor fitted. The fresh water tank has to be filled with distilled or demineralized water required for the sterilization process. The tank has a capacity of 3.7litres when filled to the correct level (see page 11), the autoclave requires a minimum of 0.5 litres before the autoclave will start a cycle. Both tanks can be drained remotely utilising the quick disconnect ports located on the front of the autoclave, (see page 12). Please use the supplied drain hose and coupling and a suitably sized water container when carrying this out.

### Volume

The fresh water tank on the Advance Pro will hold enough fresh water to complete between 3 and 4 cycles before needing to be re-filled. The waste tank on a 16 litre Advance Pro holds enough water to complete 3 full cycles before needing to be emptied and the 22 litre will complete 5 cycles before needing to be emptied.

The waste tank can be remotely drained by utilising the rear quick disconnect drain port and attaching the supplied drain tube (see supplied accessories). A professional and safe way of utilising the remote drain system is to purchase the Rapid Drain System (RDS) from Prestige Medical (see page 36 for further details)

Fresh and waste water tank capacities:

Water tank	16 Litre	22 Litre
Fresh water tank	3.7L	3.7L
Waste water tank	2.0L	3.5L

Rear view of autoclave (16L model shown)

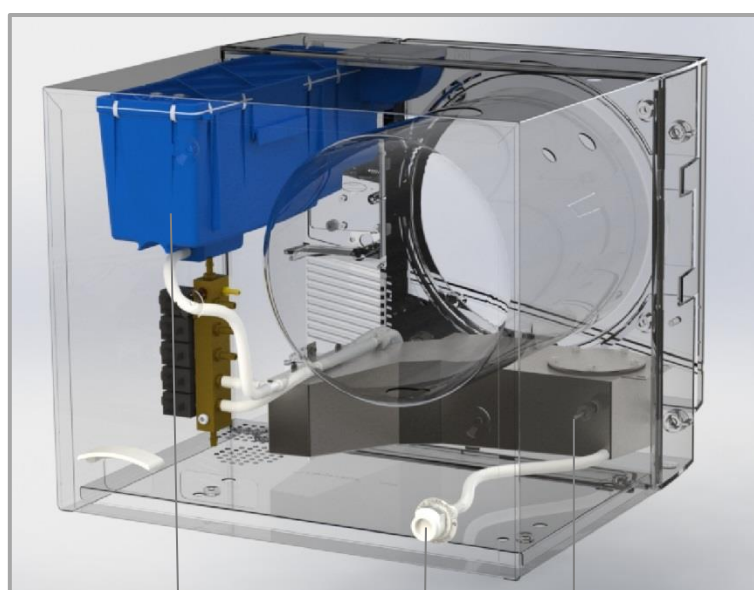

Fresh water tank

Waste water tank

Remote waste water tank drain point (rear)

Front view of autoclave (16L model shown)

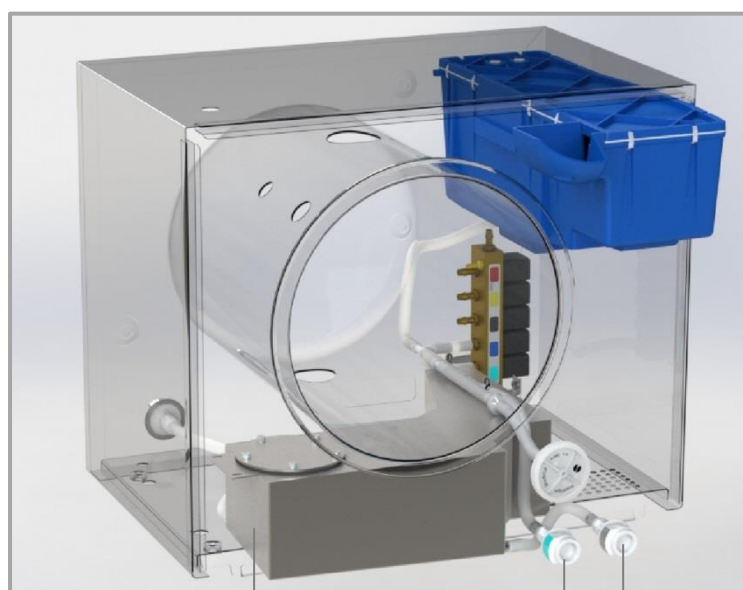

Waste water tank

Fresh water tank drain point (front)

Waste water tank drain point (front)

## Section 5: Features *continued*



### Visual Status Indicator

The visual status indicator is an illuminated strip integrated within the door assembly. This unique system enables the operator to visually see the sterilisation cycle progress



 Ready Mode:  
Blue



 Warming phase:  
Orange



 Sterilizing Phase:  
Pink



 Drying phase:  
White



 Cycle End:  
Green flashing



 Errors & Warnings:  
Red flashing

## Section 6: Rating Plate & Unit Serial number

The Advance Pro autoclave has two rating plates attached during assembly; these plates identify the model number and serial number as well as relevant regulatory standards and symbols.

Prestige Medical Ltd or your local distributor will ask for your unit serial number for machine identification purposes if the autoclave requires attention.

Rating plate locations:

Front rating plate location. Please note; the autoclave door requires opening to gain access.



Rear rating plate location.



Cycle	Description
134B	This is the factory setting default sterilization cycle of the sterilizer. The cycle is a type B sterilization cycle suitable for all types of loads; solid, porous, hollow, unwrapped, bagged, single or double wrapped that features a pre-vacuum phase, a plateau time (sterilization or holding time) of 3.5 minutes at a temperature of 134°C and a vacuum drying phase.
134B PRION	This is a special sterilization cycle in accordance with the WHO's recommendations on CJD (Creutzfeldt Jakob Disease) for a longer sterilization plateau. The cycle is a type B sterilization cycle suitable for all types of loads; solid, porous, hollow, unwrapped, bagged, single or double wrapped that features a pre-vacuum phase, a plateau time (sterilization or holding time) of 18 minutes at a temperature of 134°C and a vacuum drying phase.
121B	This is a low-temperature sterilization cycle (121°C) primarily designed to sterilize items that cannot withstand the temperature of 134°C. The cycle is a type B sterilization cycle (suitable for all types of loads; solid, porous, hollow, unwrapped, bagged, single or double wrapped) that features a plateau time (sterilization or holding time) of 16 minutes at a temperature of 121°C and a vacuum drying phase.
134N	This cycle is a type N sterilization cycle which is only suitable for solid load types. The cycle has a sterilization hold time of 3.5 minutes. This cycle is the fastest of sterilisation cycles on the unit and is recommended for use when there is a requirement for large batches of solid instruments to be sterilised.
121N	This is a low-temperature non vacuum sterilization cycle (121°C) primarily designed to sterilize items that cannot withstand the temperature of 134°C (plastics). The cycle is a type N sterilization cycle which is suitable for solid instruments only. The sterilization cycle features a plateau time (sterilization or holding time) of 16 minutes at a temperature of 121°C.
PCD	The Process Challenge Device or PCD cycle is used when carrying out steam penetration tests utilising either the Bowie Dick or Helix test device. Further information on these specific tests are given on pages 22 and 23. Prestige Medical recommends that the autoclave is checked using either one of these test methods at the beginning of each day.
Leak Test	The leak test cycle tests the efficiency of the vacuum pump along with the tightness of the pneumatic circuit (door gasket, internal hose connections). This test should be used after a consistent failure of a process challenge device as well as after fitting a new door gasket. See page 34 for further guidance.
DRY	The drying only cycle allows a wet load to be placed back into the autoclave and dried if required. There is a pre defined time of 5 minutes for the drying cycle but this can be increased in increments of 5 minutes up to a maximum of 20 minutes (see section 8)

### Load types

It is important that the correct cycle is selected for the load that is to be sterilized, never mix different loads that require a different cycle selection! Below are examples of the 4 main types of loads which will determine which sterilisation cycle to select.



Solid

Pouched /wrapped

Hollow

Porous load

Item	Vacuum cycle (B)	Non-Vacuum cycle (N)
Solid	✓	✓
Pouched	✓	✗
Hollow	✓	✗
Wrapped	✓	✗

**WARNING!**  
Before sterilizing instruments always read the manufacturers recommended sterilization guidance

# Section 8: Getting started

Important: please ensure the operator has read this user manual fully before beginning to operate the Advance Pro autoclave. Ensure the unit has been correctly installed and that it has been correctly connected to the mains supply.



Prestige Medical Limited, UK  
zing...Please Wait..

STANDBY MODE  
Press standby to go to READY MODE and enable door access.

Turn the main power switch located at the bottom right hand side of the machine to the on position (the button will illuminate green). The machine will carry out a system check for around 3 seconds and will display the text "Initializing please wait". After the system check has been completed the

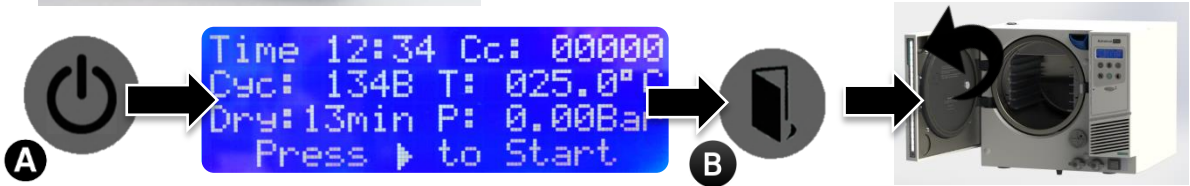

Proceed to press the standby button (A) located on the main control panel. The interface screen will then display the home screen also shown above. To open the unit door, proceed to press the door open button (B), the autoclave door will then open. Note: if there is any positive or negative pressure in the unit then it will automatically bleed this to atmosphere before allowing the door to open.

**WARNING!**  
When the sterilizer is switched ON from the standby mode, the chamber automatically heats to 120°C.



Fresh water fill: Before using the autoclave for the first time please fill with de-mineralized water. Pour water into the fill spout until it reaches the "Maximum level" as shown in the image to the left. Do not overfill. The water capacity is 3-7 litres. Always use de-ionised, distilled or sterile water as recommended (see page 35).

Note if the autoclave has water present in the fresh water tank and its age is unknown then please drain by following instructions on page 12.

Water fill level (max)

**WARNING!**  
Please use demineralized water with a reading of 15µS/cm or less, failure to do so may result in possible damage to the unit and invalidate the warranty

## Control panel detail

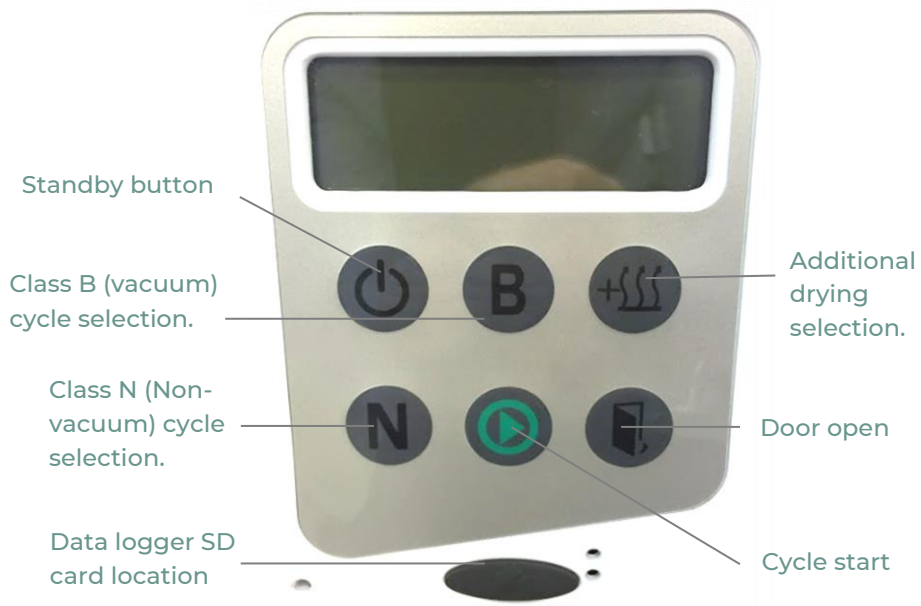
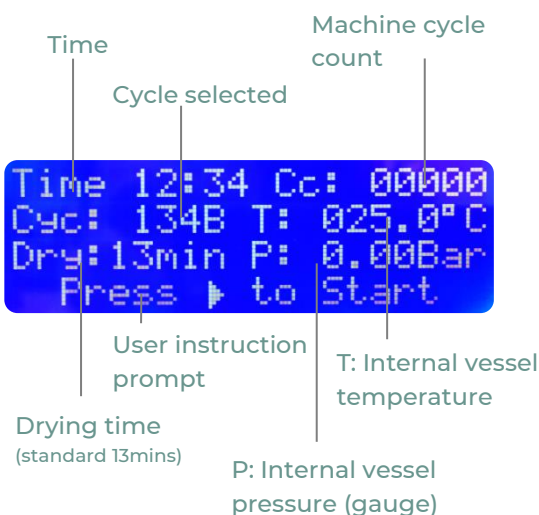

Loading: load the machine in accordance with the detailed information provided in section 19. Ensure all guidelines and instructions are correctly adhered to.

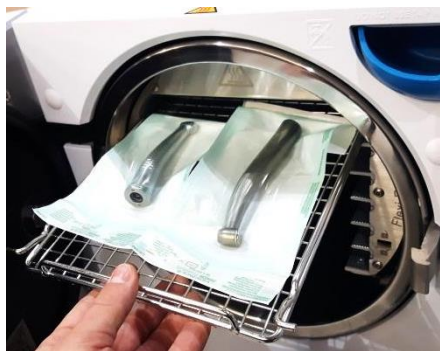

16.05 C: 1069  
134B Dry: 13min  
101.0°C 0.00  
Please Close Door

Display message when door is open

Door closing: Once the unit has been loaded, gently close the door, you should hear a “click”. If the door has not shut correctly and you try to initiate a cycle an error message will be displayed along with the sounding of an audible alarm (see image far right). Re-open the door and close again.



Close the door  
Press Start To Mute

Display message when door is incorrectly closed

### Fresh & waste water tank draining



- First remove the silicone dust cover as shown in image 1
- Place a water carrying container (4 litres min) below the level of the sterilizer and place the free end of the drain tube into it.
- Insert the drain tube into the left connector (blue) for the clean filtered water, or into the right connector (grey) for the waste water tank (*push until you hear the click*)
- Let the water flow from the tank completely into the container.
- Press the push-button on top of the quick connector to disconnect and remove the drain tube.
- Rear drain point: (see image 4) an optional rear drain kit is available and can be supplied in 3m or 6m lengths, this kit allows the waste tank to be continually drained from the rear of the machine. The drain tube can then be placed in a sink local to the machine. (Please see section 27 for part numbers)
- Drain both the fresh and waste water tanks at the end of every day.



Cycle selection:

Selecting cycles on the Advance Pro is very simple, the two buttons used for the cycle selection are B & N (see image right), button B is for vacuum (class B cycles) cycle selection and button N is for non-vacuum cycle selection (class N)



Home screen:

The image on the right is of the standard home screen. After each cycle the unit will return to the default cycle. This is the 134°C 3½min Vacuum cycle for porous loads, wrapped, pouched solid / hollow instruments with 13 minutes drying cycle.

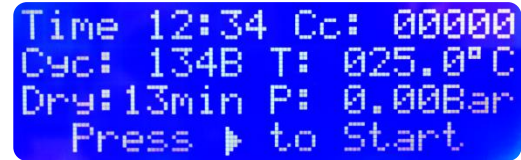

Press the button "B" to scroll through the class "B" cycle menu

Class B vacuum

134°C /3½min. Vacuum cycle for porous loads, wrapped, pouched, solid / hollow instruments with drying.

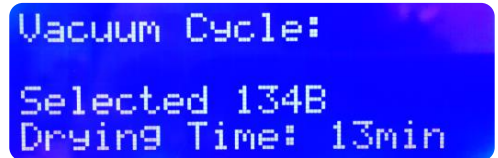

121°C /16min. Vacuum cycle for porous loads, wrapped, pouched, solid / hollow instruments with drying.



PRION(134°C /18min). Vacuum cycle for porous loads, wrapped, pouched, solid / hollow instruments with drying.

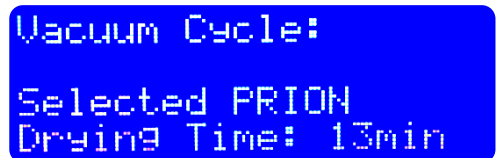

PCD. Steam penetration test without drying. Suitable for Bowie Dick Test Pack or Helix.



LEAK TEST. This checks the tightness of the pneumatic circuit to ensure that nothing is leaking.

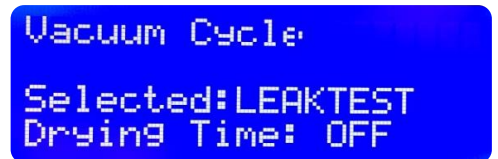

Press the button "N" to scroll through the class "N" cycle menu

Class N non- vacuum

134°C /3½min. Non-vacuum cycle for unwrapped solid instruments, without drying.

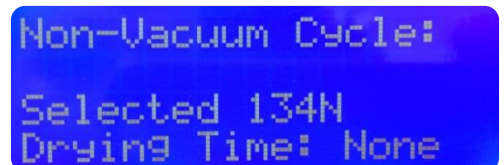

121°C /16min. Non-vacuum cycle for unwrapped solid instruments, without drying.

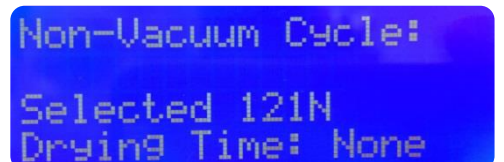



## Additional drying



If required additional drying can be added to the user selected cycle. The standard drying time is pre-set at 13 minutes; additional drying time can be added in increments of 5 minutes up to maximum of an additional 15 minutes. Press the additional drying button (as shown left) to add the additional drying time

Cycle	Standard drying time	Optional "additional" drying time	Total drying time
134C Class B	13 Minutes	5 Minutes, 10 Minutes, 15 Minutes	18 Minutes, 23 Minutes , 28 Minutes
121C Class B	13 Minutes	5 Minutes, 10 Minutes, 15 Minutes	18 Minutes, 23 Minutes , 28 Minutes
PRION	13 Minutes	5 Minutes, 10 Minutes, 15 Minutes	18 Minutes, 23 Minutes , 28 Minutes
PCD (Process Challenge Device)	none	none	none
Leak test	none	none	none
134C Class N	none	5 Minutes, 10 Minutes, 15 Minutes	5 Minutes, 10 Minutes , 15 Minutes
121C Class N	none	5 Minutes, 10 Minutes, 15 Minutes	5 Minutes, 10 Minutes , 15 Minutes

The table above explains the additional drying times available on the Advance Pro. The additional drying time will be displayed as a total drying time. The image on the right shows an example of 5 minutes added to a 121B cycle giving a total drying time of 18 minutes.

Vacuum Cycle:  
Selected 121B  
Drying Time: 18min

### Cycle start:

Once you have selected the desired cycle (load dependent) and added any extra drying (only if required). The unit is now ready to start. Press the start button as displayed below.



Press the start button to begin the cycle

Time 12:34 Cc: 00000  
Cyc: 134B T: 025.0°C  
Dry: 13min P: 0.00Bar  
Press ▶ to Start

### Drying only cycle

The drying only cycle is selected using the non -vac selection button, this cycle heats the chamber to a maximum temperature of 134°C for 5 minutes only. Additional time can be added by pressing the additional drying button; this adds extra drying time in increments of 5 up to maximum of 20 minutes.

Non-Vacuum Cycle  
Selected: DRY  
Drying Time: 5min



Press the non-vac button to scroll through the cycle list until reaching the drying only cycle.

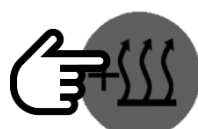

Press the additional drying button to increase the drying time.



Press the start button to begin the cycle

## Section 9: Delayed cycle start

The Advance Pro unit can be pre-programmed to delay the start of a sterilisation by up to a maximum of 24 hours prior. Developed to optimise workflow the Advance Pro steriliser enables users to programme sterilisation start times to take advantage of lower electricity costs at certain times of the day. This feature can also be used to prevent any overloading of the electrical systems caused by simultaneous use of several devices or simply to have the steriliser ready at the start of the next working day. Follow the guidance below to help initiate a delayed cycle start time.

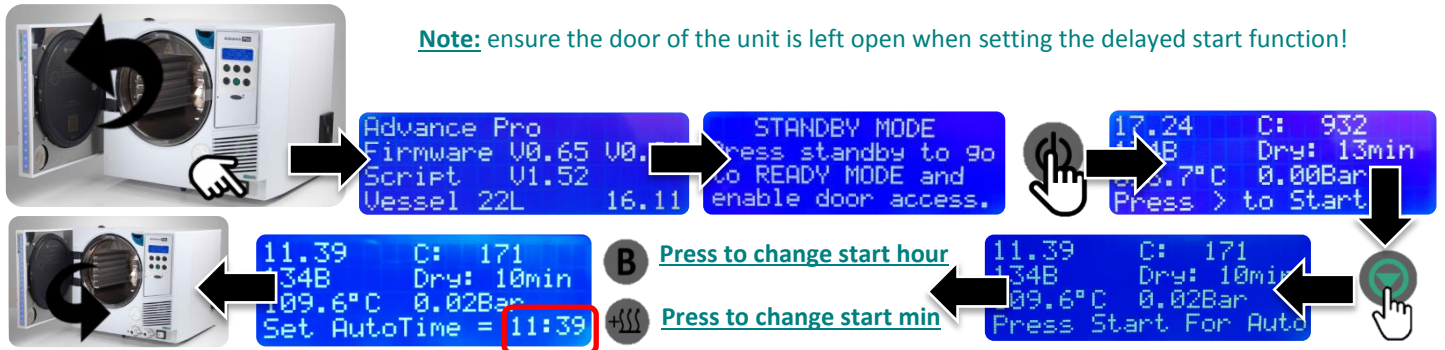

- Close the door to start the delayed cycle sequence

## Section 10: Time

On installation of the autoclave the service engineer will set the current local date and time.

Please follow the following instructions should the time require changing to suit local winter and summer daylight saving hours.

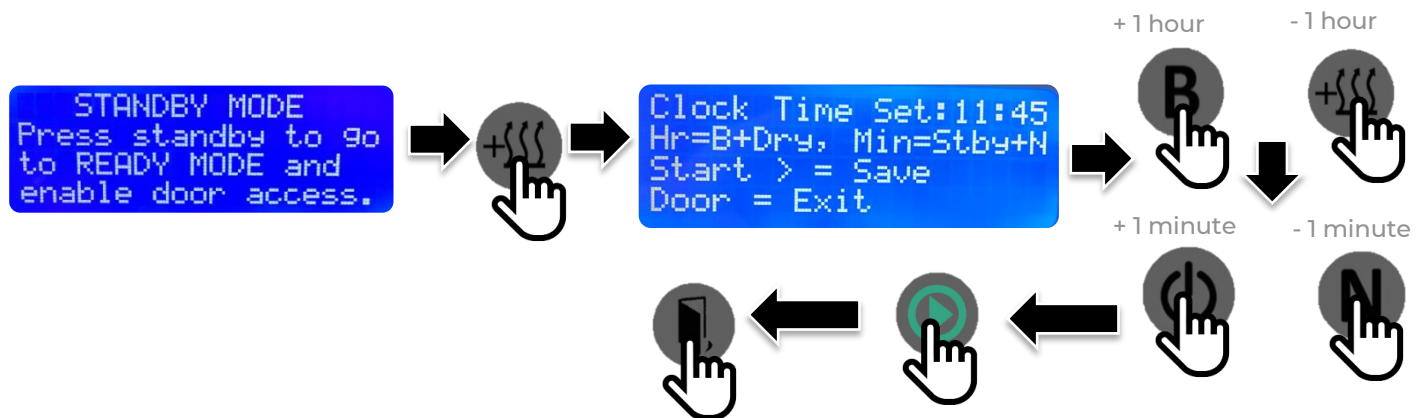

## Section 11 Data recording

### 8.1 SD Memory card recording system

The Advance Pro autoclaves are equipped with a digital cycle data recording system.

Cycle data is written and saved on removable / rewritable SD memory cards.

- Lift the rubber cap located on the front of the autoclave and insert the SD memory card into the dedicated slot until it clicks into its final position. Ensure that the flat corner of the card points to the top/right (see image to the right).  
At the end of everyday remove the memory card to download cycle data to a computer.
- To remove the memory card, pull it out gently & replace the rubber cap.



Additional SD memory cards are available for purchase from Prestige Medical Ltd.  
Part No. 579022



**Important!**  
It is not possible to retrieve previous cycle history if the SD card was not inserted prior to commencing the sterilization cycle



*Note: only use genuine Prestige Medical SD memory cards*

### 8.2 Connecting the optional printer

Prestige Medical Ltd recommends the use of the dedicated thermal printer only (part number 279519). This printer has been tested for compatibility with the sterilizer and its software.

Connection:

- Connect the printer cable to the 25-pin parallel port socket at the back of the sterilizer (see image right) and then connect the other end to the printer ensuring it clicks when pushed into the socket.
- Connect the printer mains power cable
- Connect the RJ45 cable to th

Place the printer on the worktop at the side of the autoclave.

Do not place the printer on the top of the autoclave. Make sure the paper is kept away from hot surfaces.

Store the printouts in folders away from direct or indirect sunlight.

For more detailed information please refer to the instructions supplied with the printer.

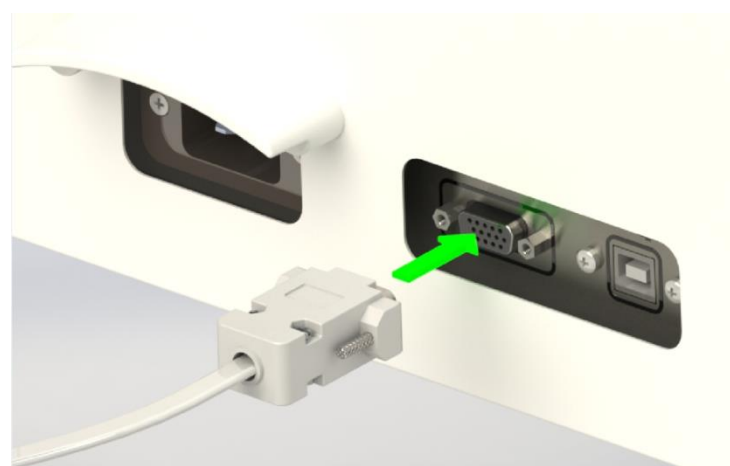

## Section 12: Essential information

To ensure that the autoclave continues to operate correctly, it is important to adhere to the following points and to carry out the necessary care and maintenance procedures as specified. This product is not a washing / cleaning machine.

### Do ensure that.....

- ... you read and follow these Instructions for Use.
- ... the load is suitable for sterilizing and the cycle selected.
- ... the load can be sterilized at the selected temperature.
- ... the load has been cleaned.
- ... the load has been rinsed thoroughly in clean water prior to sterilization to avoid any chemical residues left after cleaning contaminating the autoclave.
- ... when placing instruments on trays, ensure that they do not touch each other and must not interfere with other trays or the chamber above.
- ... only distilled, de-ionised or sterile water is used (as recommended on page 35).
- ... the autoclave is in a draught free area.
- ... the autoclave is not installed in an enclosed cupboard space.
- ... the door is left ajar when not in use.
- ... you quote model/serial number (which are located on the lower right hand side of the front bezel, behind the door moulding and also on the rear case just above the mains power cord entry) and date of purchase in all correspondence.
- ... only qualified personnel regularly service the autoclave.

### Do not....

- ... lose this user manual.
- ... add any chemicals whatsoever to the water.
- ... attempt to sterilize volatile substances, toxic materials or other unsuitable loads. (Refer to your "Responsible Person" for advice)
- ... place the autoclave in direct sunlight.
- ... place the autoclave on heat sensitive surfaces.
- ... use inappropriate cleaning materials.
- ... drop or abuse the autoclave.
- ... use in areas of risk associated with flammable materials or gases.
- ... remove the casing or attempt to service or repair the autoclave.

**It is recommended that a Chemical Indicator strip be used every cycle to verify that the sterilizing cycle is effective. If the Chemical Indicator strip fails to change colour repeat the cycle. If it still fails to change colour then arrange for a service.**

## Disposal

### WEEE Statement (Waste, Electrical and Electronic Equipment)

The WEEE directive places an obligation on all EU-based manufacturers and importers to take-back electronic products at the end of their useful life. Prestige Medical Limited accepts its responsibility to finance the cost of treatment of redundant WEEE in accordance with the specific recycling requirements. The symbol (shown right) is present on all Prestige Medical products, which indicates that the product must NOT be disposed of with other waste. Instead it is the user's responsibility to dispose of their waste electrical and electronic equipment by handing it over to an approved reprocessor, or by returning it to Prestige Medical for reprocessing. For more information about where you can send your waste equipment for recycling, please contact your local city office or Prestige Medical.

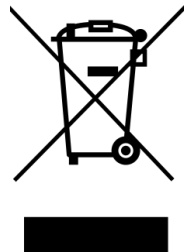

## Section 13: 1 Year Warranty

Prestige Medical Ltd will, in the first 12 months from the date of purchase (or 18 months from the date of factory despatch – whichever is first), repair or replace free of charge any parts\* inclusive of labour which prove to be defective in workmanship and / or materials.

Prestige Medical Ltd will not be liable in the event that the purchaser has failed to adhere to the instructions contained herein or if the autoclave has been abused, interfered with, altered, repaired or serviced by any unauthorised party. This may result in the protection provided by the equipment being impaired.

\* This warranty excludes the door gasket, pouch trays and consumables.

Consumer's statutory rights are not affected.

The Prestige Medical Ltd policy is one of continuous development and as such reserves the right to change the specification of the models and items illustrated and described herein at any time.

Overseas customers:

Please contact your local distributor for conformation of warranty agreements.

## Section 14: Cleaning & routine maintenance

### Daily Maintenance

**IMPORTANT! THE GASKET AND VESSEL RIM MUST BE CLEANED ON A DAILY BASIS, BEFORE USING THE AUTOCLAVE.**

Wipe exposed surfaces of the gasket with warm soapy water using a lint free damp cloth or sponge. Using A nylon pan scourer clean the vessel sealing rim using a circular motion, wipe both the gasket and the vessel again with water using a lint free damp cloth to remove any residual soap.

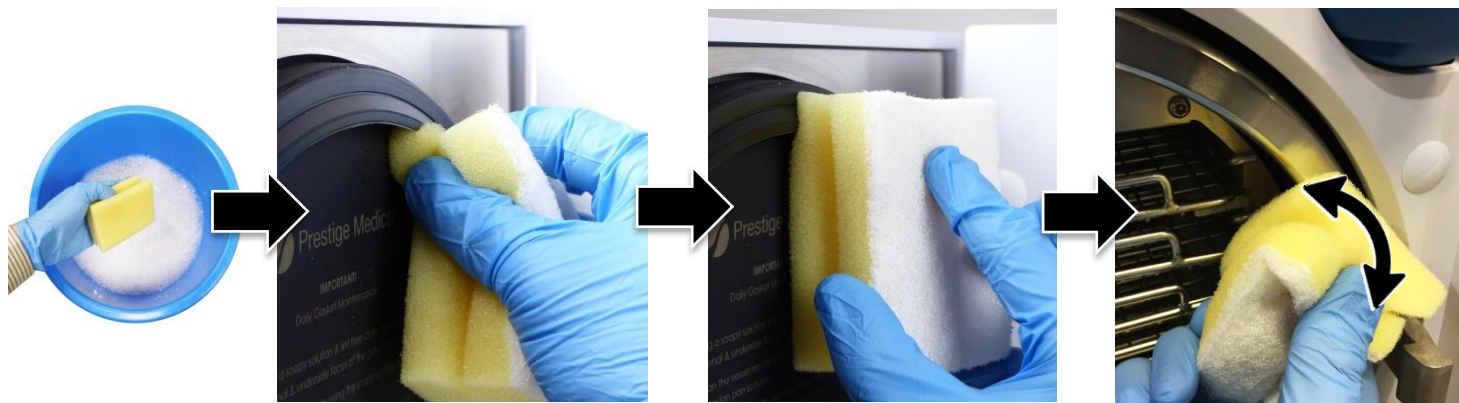

Clean under the gasket thoroughly as shown above

Clean the exterior surface of the gasket carefully, do not use excessive pressure.

Use a circular motion when cleaning the vessel rim



### WARNING

Failure to perform these procedures may result in the unit displaying error 1,3 or 7 on the display. These errors can be caused by not carrying out the appropriate maintenance procedures instructed in this manual.

### Maintenance reminders :

#### *Cleaning required*

This message will be displayed every 250 cycles, and it is expected that the end user carries out the internal system cleaning method as instructed on page 19.

#### *Service required*

A service reminder will appear on the display screen after approximately 12 months since the last service was carried out by an authorised service engineer.

*Note:* Press any button on the control panel to clear the maintenance reminders.

Cleaning required  
Refer to the manual  
Press any key  
to continue

[ User Information ]  
Service Required

### Monthly Maintenance:

#### *Fresh water tank*

On a monthly basis, fully drain the fresh water tank and refill with 2 caps of the autoclave cleaning solution and 1 litre of distilled water and leave overnight. Drain the fresh water tank then refill with fresh water. Repeat the tank flushing operation twice more to remove any cleaning residue. Always use de-ionised, distilled or sterile water as recommended. NEVER USE TAP WATER.

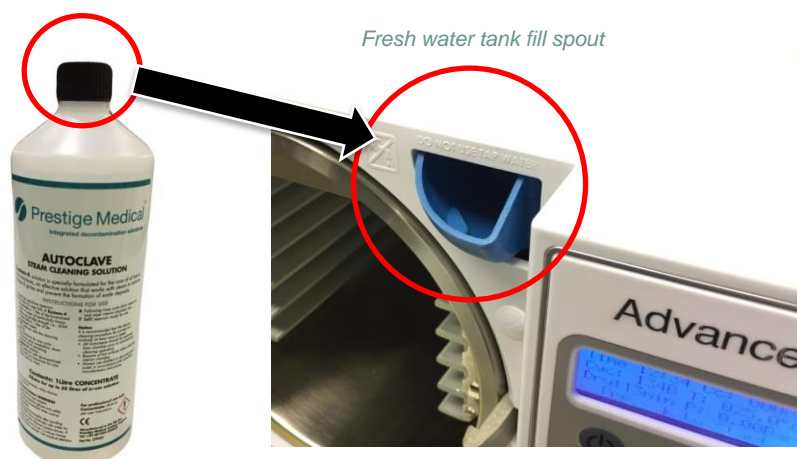

*Prestige Medical  
autoclave cleaning  
fluid: Part No. 279493*

**IMPORTANT!** Only qualified personnel should regularly service & maintain the autoclave

### FlexiRack cleaning

It is important that the FlexiRack system is regularly cleaned on a monthly basis to help maintain its key function of being user configurable. Please follow the simple guide below and ensure the autoclave has adequately cooled down before carrying out any maintenance.

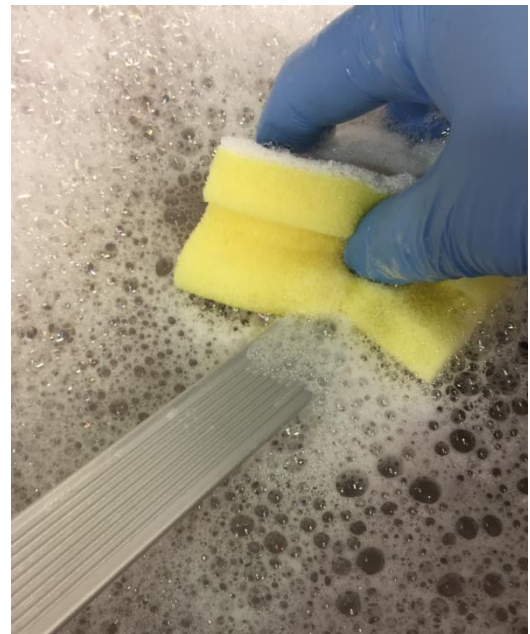
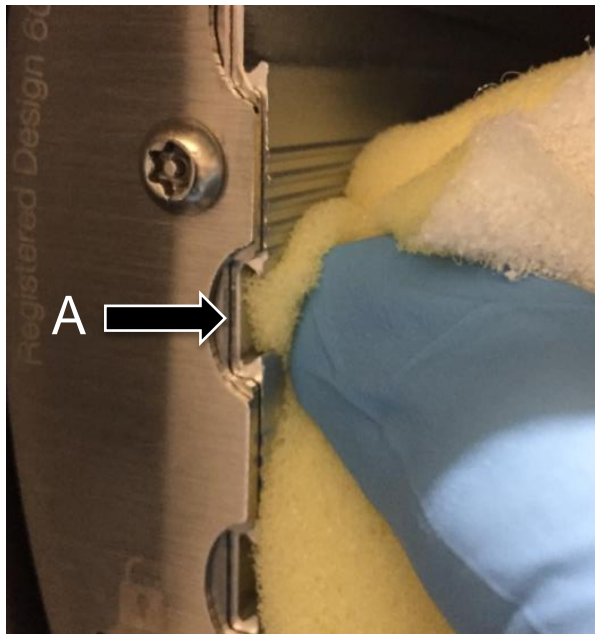
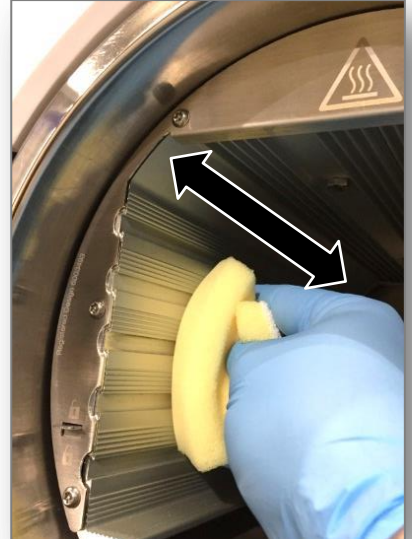
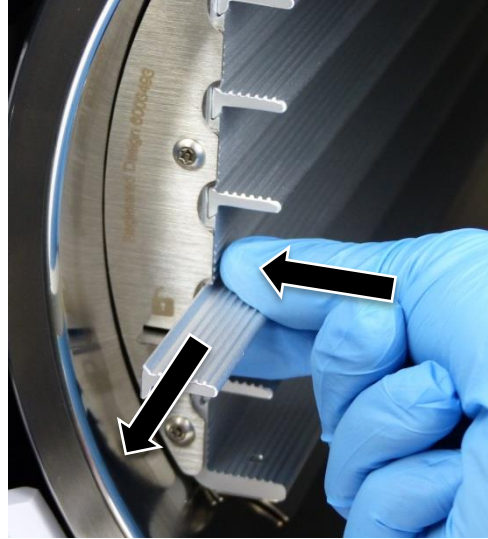

Ensure the individual rails and rail guides are cleaned thoroughly as shown in the images above, this ensures reliable operation of the FlexiRack. Ensure the individual rail guides (A) are cleaned thoroughly & correctly, a sponge is best suited to carry out this procedure as it self-forms to the rail guide shape.

Every 250 cycles:  
Internal system cleaning

The autoclaves internal system has to be cleaned every 250 cycles using the specifically formulated Prestige Medical autoclave cleaning fluid. This fluid removes any harmful oil residue and light mineral staining from the autoclaves inner workings. First fully drain the fresh and waste water tank and refill the fresh with 2 caps of the autoclave cleaning solution and 1 litre of distilled water. Turn the autoclave on as shown in section 8 and close the door and proceed to select and start the 134N cycle. After the cycle has finished please empty the fresh and waste water tanks and refill the fresh water tank with distilled water. Run one more 134N cycle and drain both tanks after the cycle has completed. Refill the fresh water tank – the unit is now ready for use.



Prestige Medical autoclave cleaning fluid: Part No. 27945



**WARNING!**  
Please use demineralised water with a reading of 15 µS/cm or less failure to do so may result in possible damage to the unit.

Every 500 cycles:  
Exterior surfaces

Clean exterior surfaces using warm soapy water only and a clean non-abrasive cloth; do not use excessive amounts of water to wash the sterilizer as this may damage the electrical components and safety mechanisms.

Take care not to scratch the plastic film in front of the LCD display-screen; avoid cleaning it with detergents or pointed objects.....only qualified/experienced personnel should regularly clean the autoclave.

Air filter

To change the air filter located at the front of the autoclave, gently pull the air filter from the front of the machine ensuring the black silicone securing bush does not become detached from the machine.

Correctly dispose of the old filter and replace with a new one. Please ensure the new filter is pushed in all the way to the front face of the machine (see image right)



Prestige Medical autoclave air filter: Part No.579034



**ATTENTION!** Disposal of used consumables shall be done in compliance with local laws and rules

Every 12 months:

As a minimum Prestige Medical recommends that the filter located on the right hand side of the machine is replaced every 12 months. If the unit is situated in a place where there is a high contamination risk from airborne dust and foreign debris then the filter should be periodically checked every 4 months and replaced if found to be excessively contaminated. Note; failure to replace the filter could result in a SE07 ERROR

To replace the filter please follow the instructions given below

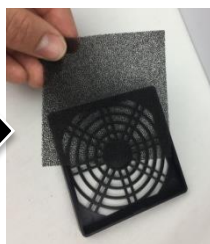

Fan filter  
Part Number: 579015

First un-clip the external filter housing by pulling from the top of the housing, remove the old filter and discard. Place the new filter in the housing and re-install.

### Gasket maintenance & replacement

Should the gasket develop a persistent leak it should be removed, cleaned thoroughly in warm soapy water and shaken dry, wiping with a lint-free cloth is acceptable (other materials may lead to contamination of the gasket with fibres) and then replaced. Please follow the following procedure to ensure the gasket is removed and replaced correctly. If the leak persists you should obtain and fit a new genuine Prestige Medical gasket. Prestige Medical recommends that the door gasket is changed every 500 cycles.



Gently pull the gasket from the autoclave door from one point only, as shown in the images above. With the gasket removed please clean the door face and the gasket mounting slot using a soft sponge with warm soapy water.



Install the new gasket as shown in the two images left; please ensure the slot is located at the top of the door when installing the gasket.



Continue to press the gasket into the slot, checking that the gasket seal is being pressed into the slot correctly. Press the gasket into the door by first pressing the top and bottom and then moving to the left and right hand side of the gasket as shown above.



Press the remaining sections of the gasket into the autoclave door, continually checking it has been pressed in correctly.



Please visit our youtube homepage for video guidance on gasket care and replacement installing the gasket.



## Section 15: Direct water feed & Rapid drain system

### Direct water feed system

The Advance Pro is available with a direct water feed option, this direct feed connection is only available as a factory fit option. The diagram below gives a typical installation example when connecting to an existing RO system.

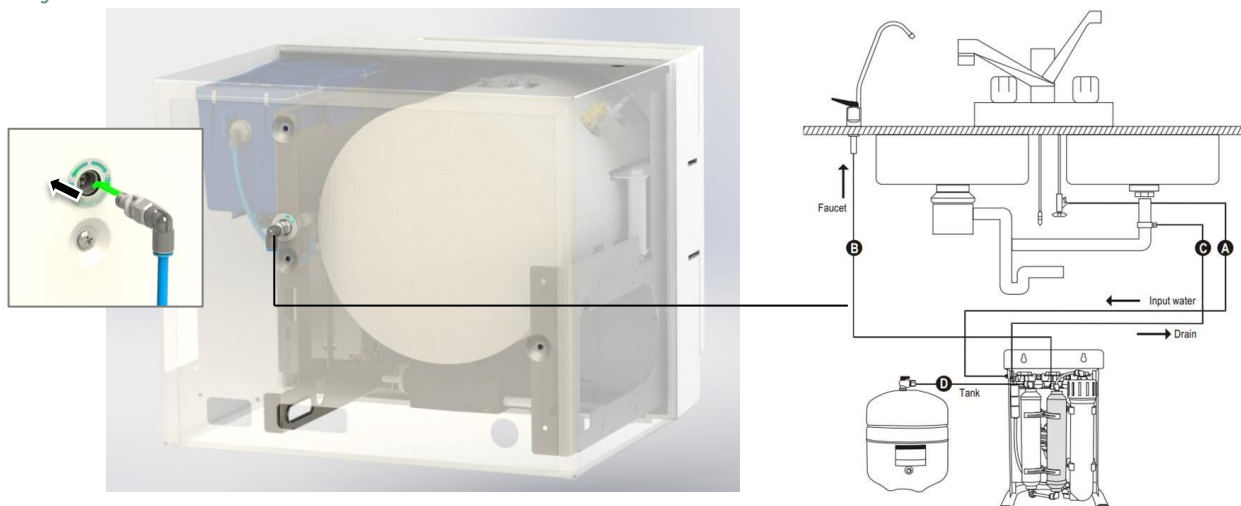

Please refer to the supplied direct feed installation instructions for further details.



#### WARNING

Prestige Medical recommends that when utilizing the direct feed system the unit should be permanently connected to a local drain point by using the rear drain connector located on the rear of the machine. Prestige Medical also recommends that the water supply to the machine should be isolated at the end of everyday.

# RDS

**Rapid Drain System:** This system reduces the risk of end users coming into contact with hot waste water and allows the Advance Pro waste tank to be directly connected to the main drain system within the practice.

The RDS is available as an accessory from Prestige Medical and can be fitted by a competent person.

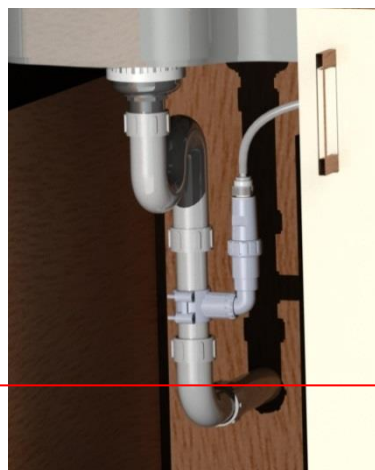
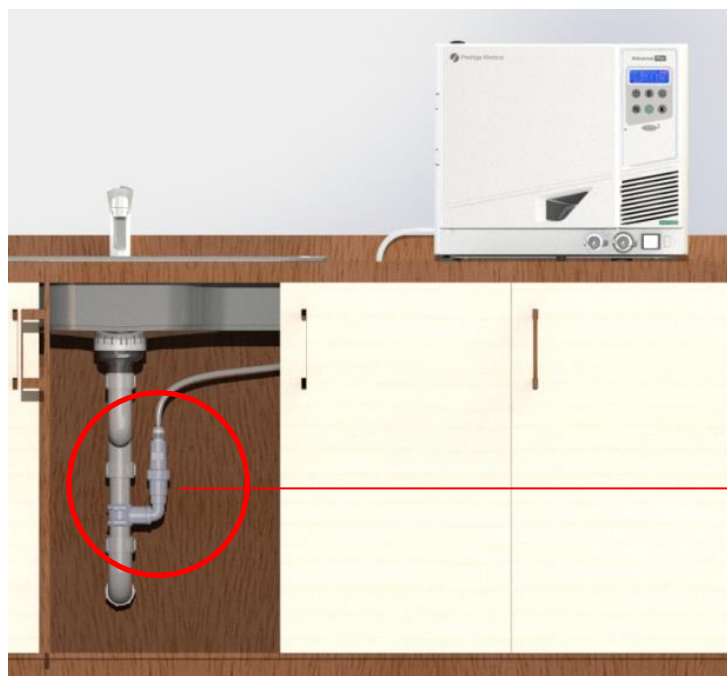

## Section 16: Bowie Dick test

Prestige Medical Ltd recommends that a steam penetration test is carried out on a daily basis to ensure that the machine is working correctly. There are two test devices which allow the operator to carry out such a task, these are known as the Bowie Dick test (see below) and the Helix test device (see page 23).

The Bowie Dick (B&D) Test device, also called Steam Penetration Test device, is representative of a small porous type load. It comprises several sheets of paper wrapped in a small packet in the middle of which there is a chemical heat-sensitive indicator sheet. This test is used to validate the sterilizer performance in terms of textile load sterilization.

- Pre-vacuum efficiency and thus steam penetration
- Temperature and pressure parameters of saturated steam achieved during the plateau/holding time.

How to carry out the test:

- The test must be performed in an empty chamber (EN 13060) without load but with the standard chamber accessories (chamber rack and trays) mounted.
- Place the Bowie Dick test pack in the centre of a tray in the lowest rack position.
- Select and start the PCD (Process Challenge Device) cycle from the vac cycle menu using the button **B**
- Once the cycle is finished, open the sterilizer door and remove the test pack.
- Remove the indicator sheet from the centre of the test pack and check the change in colour as explained below:

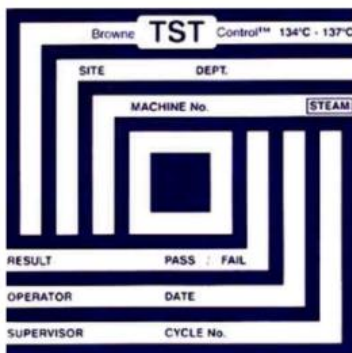

### TEST PASSED

The entire surface of the indicator sheet has changed colour

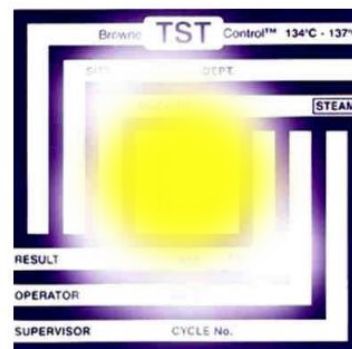

### TEST FAILED

Certain areas of the indicator sheet have not changed colour, e.g., the central part has not turned dark due to an air pocket in the center of the test pack

Any unexpected colour change, such as the centre of the indicator sheet being paler or of a different colour than the edges, indicates that there was an air pocket present during the cycle due to sterilizer malfunction. If the test fails repeatedly call technical service. Follow local/national guidelines on the frequency of testing.

## Section 17: Helix test

The Helix Test device is representative of a hollow load (EN 13060). It consists of a 1,500 mm long tube that is open on one side and closed with a capsule on or at the other side or end. An indicator strip is placed inside of the capsule. This test is used to validate the sterilizer performance in terms of hollow A load sterilization, that is:

- Pre-vacuum efficiency; rapid and uniform steam penetration.
- Temperature and pressure of saturated steam achieved during the plateau/holding phase.

How to carry out the test:

- The test must be performed in an empty chamber (EN 13060) without load but with the standard chamber accessories (chamber rack and trays) mounted.
- Place an indicator strip inside the capsule. See the test manufacturer instructions.
- Close the capsule.
- Place the Helix Test in the center of a tray in the lowest rack position.
- Select and start the PCD (Process Challenge Device) cycle from the vac cycle menu using the button
- Once the cycle is completed, open the sterilizer door and remove the test.
- Remove the indicator strip from the capsule and check the change in colour as explained below:

Pass



The chemical indicator has turned dark.

Fail

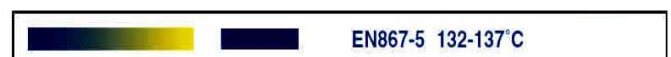

Part of the chemical indicator has not turned dark; e.g. due to residual air inside the capsule.

Insufficient colour change of the indicator strip indicates that there was an air pocket present during the cycle due to sterilizer malfunction. If the test fails repeatedly call technical service. Follow local/national guidelines on the frequency of testing

A Prestige Medical Albert Browne Test Helix MUST be used with this test. The Helix should be placed on an instrument tray in the middle of the chamber towards the front.

- Helix Test Pack & 30 TST (Part No. 329001)
- Helix Test Pack & 250 TST (Part No.579016)



## Section 18: Specification

Chamber Capacities	16 Litre	22 Litre
Overall product width	480mm	480mm
Overall product height	410mm	410mm
Overall product depth	440mm	610mm
Unpacked weight	39.5 kg	43.5 kg
Chamber diameter	250mm	250mm
Chamber length	340mm (max)	470 mm (max)
Max instrument length	320mm	450mm
Max load non-vacuum	6 kg	6kg
Max load vacuum * Pack size 110x110x50mm	6 kg (un-pouched)	6 kg (un-pouched)
	2kg (pouched)	2kg (pouched)
	1 kg (porous)*	1 kg (porous)*
Sterilizing temp/time	134°C / 3.5 mins	134°C / 3.5 mins
	134°C / 18 mins	134°C / 18 mins
	121°C / 16 mins	121°C / 16 mins
Operating Pressure (min)	2.05 Bar (gauge)	2.05 Bar (gauge)
Voltage / Wattage	230V / 2200W	230V / 2200W
Frequency	50 - 60 Htz	50 - 60 Htz

NB. The overall cycle time will increase as the mains supply voltage decreases.

Chamber component materials.

Vessel: Stainless Steel – 304 –S15

Boiler: Aluminium – LM25

Drying heater : Aluminium – LM25

Lid: Aluminium – ASME SB26 356.0 T6

Mains plug top fuse (user replaceable)

F13A to BS1362 UK only.

Rating:

All products are rated for intermittent use, continuously.

Heaters: Cast into the boiler. Internal drying heater.

Temperature cut out:

Boiler: Bi-metallic type rated at 250°C with automatic reset.

Drying heater: Bi-metallic type rated at 180°C with automatic reset.

Pressure release valve:

Operates at 2.9bar. Accumulation is <10%.

Maximum single fault temperature: 143°C determined by the pressure release valve.

Over voltage category: Group II

Pollution degree: Group II

Insulation: Class I.

Environmental conditions:

Indoor use at an altitude of up to 2,000m.

Ambient temperature range +10°C to +40°C

Maximum relative humidity 80% for temperatures up to 30°C, decreasing linearly to 50% at 40°C.

Mains supply voltage range 207 to 254volts.

Drying performance may be affected by local environmental conditions.

Safety shutdown:

The machine is fitted with two automatic thermal reset mechanisms. In the event of the boiler or drying heater overheating (for example due to accidental overload), the unit will power down. After approx. 10 minutes, power will automatically be restored and the display will show Error 16. The load will need to be re-processed, ie start the cycle again.

Storage:

When leaving the unit standing idle for any length of time,

please switch mains off and drain the water tank especially if there is a possibility of the room temperature dropping below freezing point.

Packaging:

Packing materials used have been selected for ease of recycling. Please ensure you use the correct disposal system for disposal of packing materials.

Maximum water usage:

Vacuum cycles = 600ml per cycle (typical).

Non-Vacuum cycles = 450ml per cycle (typical).

Maximum power used:

16 Litre = 1.18kwh

22 Litre = 1.33kwh

LEQ Sound level:

60db

## Section 19: Additional information

### Operator:

The person assigned to use the autoclave.

### Responsible person:

The person who is responsible for the management of the equipment, load assignment, care and maintenance. This person is also responsible for ensuring that all applicable Health & Safety Regulations are applied including those relating to the pressure vessel. This person must verify that only suitably qualified persons undertake repair and maintenance work other than that described under "Routine Care and Maintenance" within this user manual.

### Qualified person:

A person who is qualified by training or experience to a recognised level in respect of the work to be undertaken.

### Service:

Calibration and maintenance as required.

### Manual handling:

Due to the weight of the unit two people are required when unpacking or moving the product.

### Unpacking:

When lifting the unit out of the box ensure there is one person on either side of the unit. Lift out of the box and place on the work surface.

### Positioning:

Start lifting by holding the unit below the front bezel (large plastic moulding). As clearance is gained, lift at the other corners. Place in position, and release in the reverse order to lifting. NOTE Always drain the water tanks before moving. Before moving always allow 30 minutes after use for the unit to cool down.

### Cleaning materials:

Mild washing up liquid. Non-abrasive cream cleaner. Disinfectant diluted in water. Autoclave Cleaning Kit 579005.

### Product decontamination:

Should the unit require repair, it must be decontaminated in accordance with a recognised procedure prior to return or on-site repair. A statement of equipment contamination status must be available with the product. Details of a suitable procedure are available on request from Prestige Medical Ltd.

### Approvals:

- 93/42/EEC Medical Device Directive (MDD)
- 2014/68/EU Pressure Equipment Directive (PED)
- 2012/19/EU Waste Electrical and Electronic Equipment (WEEE)
- 2004/108/EEC The European Union EMC Directive
- BS EN 13060: 2014 Small steam sterilizers
- BS EN 61010-1:2010 Safety requirements for electrical equipment for measurement, control, and laboratory use
- BS EN 61010-2-040:2015 Safety requirements for electrical equipment for measurement, control, and laboratory use. Particular requirements for sterilizers and washer-disinfectors used to treat medical materials
- BS EN 61326-1:2013 Electrical equipment for measurement, control and laboratory use. EMC requirements.
- HTM 01-05
- RoHS Directive 2011/65/EU

## Section 20: Loading

Loading has a significant impact on how the autoclave performs, the maximum permissible loads are as follows: -

6 kg for Non Vacuum Cycles, 6 kg for Vacuum cycles (un-pouched), 2 kg for Vacuum cycles (pouched), 1 kg for Vacuum cycles (porous load)

Always use the supplied instrument trays and load the instruments so that they do not touch other instruments or the chamber. Failure to follow these instructions may cause the unit to malfunction and result in an unsuccessful cycle. Before loading, ensure instruments are cleaned and rinsed thoroughly.

Important!

- Please ensure that all detergent is thoroughly rinsed from the instruments before sterilizing.
- DO NOT over oil hand pieces (always check the manufacturers guidelines for lubricating hand pieces)
- DO NOT use indicator tape for sealing pouches as this can damage the internal workings of the autoclave.

Failure to comply with the above could damage your machine and invalidate your warranty

When using pouches please ensure that they are arranged so that they do not touch or overlap neighbouring pouches. When loading the trays into the rack use the top rungs of the rack first and work down. Pouches should be placed on the supplied pouch trays with the paper side down as shown below. Please ensure that there is adequate space between the trays, this will ensure that there is a good airflow between the trays and help improve the drying process.

Linen or porous loads should be formed into a rectangular pack of size 110mm x 110mm x 50mm. (maximum), weighing no more than 1 kg. Place on a pouch tray in the middle of the chamber. Linen loads should not be sterilized in combination with other loads.



### Implant kits & abnormal sized loads:

To help load implant kits or abnormal sized loads into the Advance Pro, a specifically designed implant tray is available as an optional extra. This tray allows loads to be placed vertically or at a slight angle to maximise load space within the autoclave vessel.

*Note: Prestige Medical does not recommend placing loads directly into the vessel without the use of the supplied pouch trays or optional implant tray.*



Implant tray (Part No.579026)



### Maximum instrument lengths:

- 16 litre Advance Pro = 320mm      22 litre Advance Pro = 450mm



#### WARNING!

Never overload the autoclave! Check & ensure that the instruments requiring sterilization are suitable for this type of sterilization process

## Section 21: Emergency door release

### Door opening – Power loss

If the machine has suffered a loss of power and it is essential to open the machine to remove instruments, the following

procedure should be followed. This should only be performed by the nominated responsible person:

1. Disconnect the unit from the mains supply.
2. Allow the machine to cool down to room temperature.
3. Lift up the vessel pressure release button located on top of the machine.(see images below)
4. Gently pull the button upwards as indicated below, note: when you begin to pull the button you will hear the pressure and visually see steam exiting from the pressure release button hole.
5. After you can no longer hear or see steam exiting the pressure release button hole insert the straight end of the emergency door release tool into the interlock lever release guide hole and push inwards.
6. If the unit door still doesn't open please repeat step 4

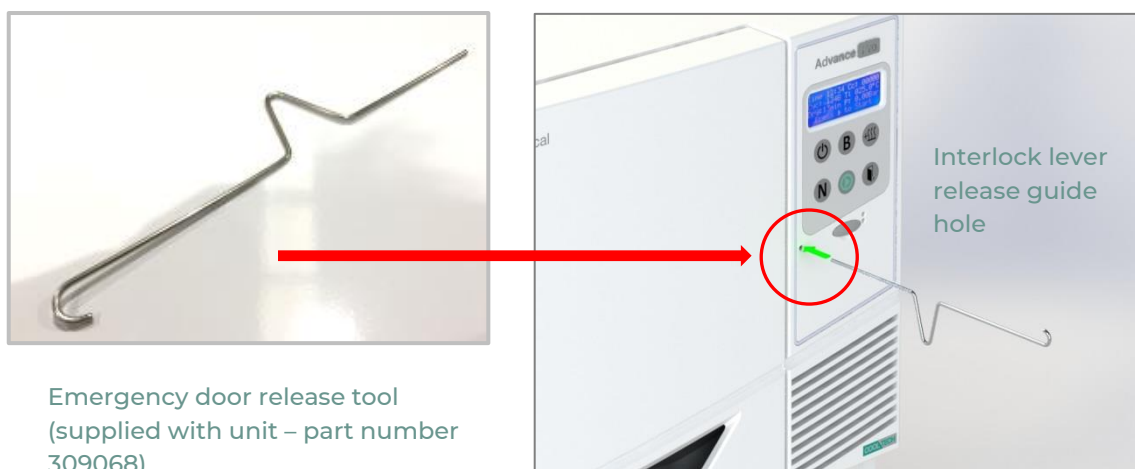
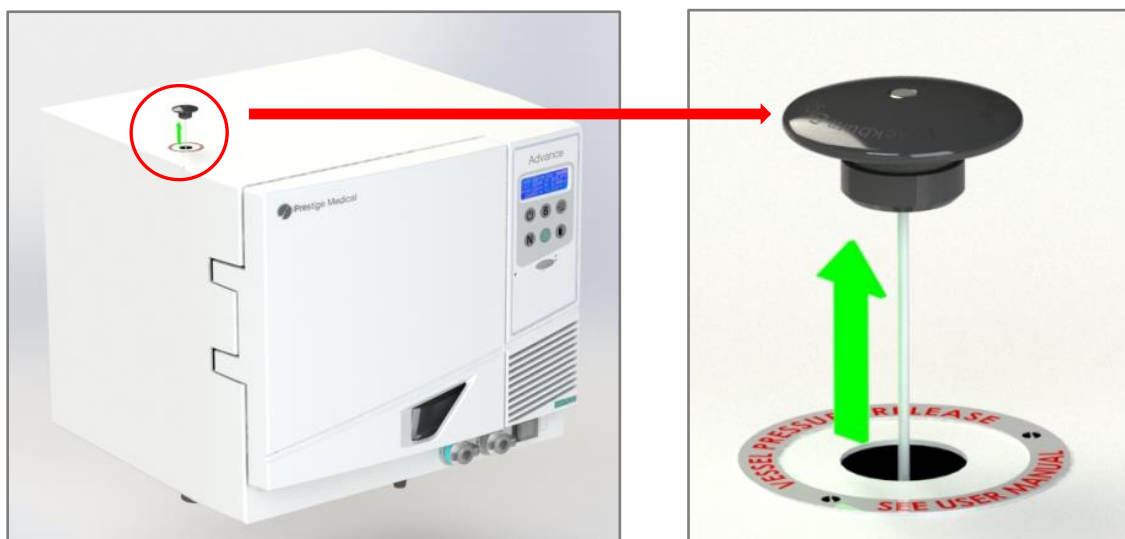

Emergency door release tool  
(supplied with unit – part number  
309068)

ONLY USE THE TOOL PROVIDED AND FOLLOW THE INSTRUCTIONS ABOVE TO GAIN ACCESS TO THE MACHINE.



**WARNING!**  
DO NOT ATTEMPT TO OPEN THE VESSEL IF PRESSURISED

## Section 22: Recovery sequence

The Advance Pro utilises advance control software which allows the unit to automatically carry out a recovery sequence in the event of:

- Losing power and regaining power during a cycle (failure of external power source)
- Accidental power loss (user switching unit off at mains or disconnecting power lead)

Should an external power failure occur, the autoclave door cannot be opened until the unit has been left to cool for approximately 30 minutes. Access can then be made using the supplied tool following the procedure in section 19.

In the event of failure of an indication device a service will be required to correct the condition.

### Primary safety features:

Three primary features have been fitted – a pressure release valve, boiler over temperature safety cut out and a drying heater over temperature safety cut out.

An indication of the boiler or heater over temperature safety cut out switch operating is that the machine will lose power internally even though it is still powered externally.

An indication of an over pressure release valve operating is a loud hissing noise coming from the machine along with excessive amounts of steam.

In the event of any of the primary safety features operating then please disconnect the unit from the external plug socket and call for a service.

## Section 23: Manual stop

Whilst a cycle is in progress, you can abort it manually at any time by pressing the standby button. Please follow the sequence below when carrying out a manual stop. (Only until the home screen is displayed can you open the autoclave door to gain access to the load).

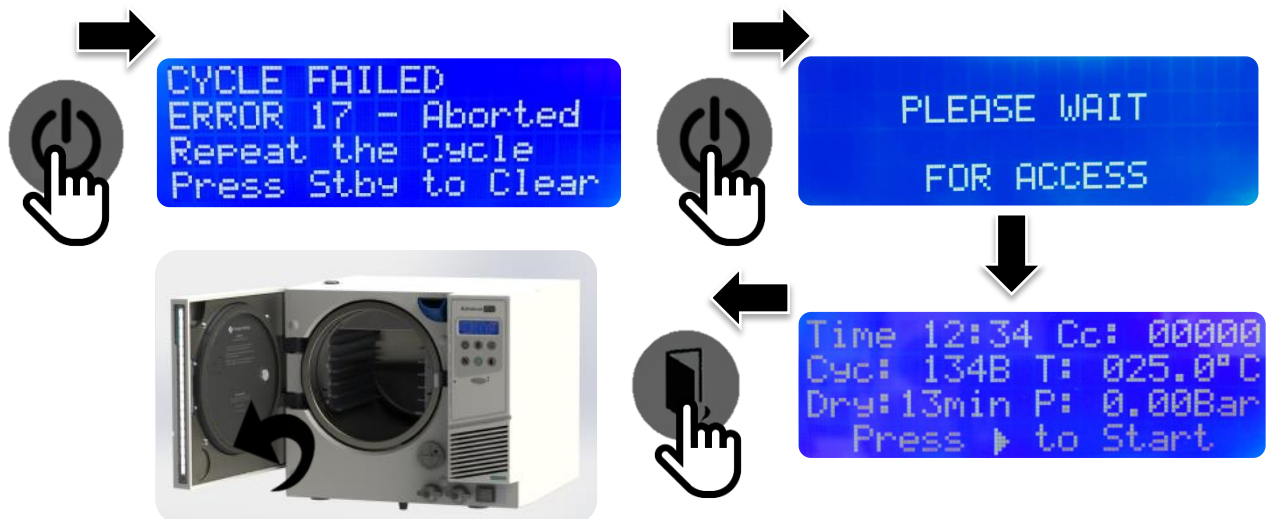

**WARNING!**  
 The load will NOT be sterile if the cycle has been manually stopped!  
**ALWAYS** repeat the sterilization cycle on the load which has been manually stopped.



## Section 24: Trouble shooting

If the machine does not complete a sterilizing cycle, a visual and audible indication will be given. The reason can then be determined by reference to the guide below. The recovery sequence allows access to any instruments within the autoclave and is the first step when rectifying the condition. In the unlikely event that a cycle fails to complete, instruments should be reprocessed as they may not be sterile.

Error code	Description	Reason	Action
1	VACUUM TIME OUT	Too long to reach vacuum set point.	Clean gasket and vessel, see section 11 ( <i>replace gasket after 500 cycles</i> ). Repeat the cycle. If the problem persists, call service.
2	FILL TIME OUT	Too long to fill the boiler.	Repeat the cycle. If the problem persists, call service.
3	PRESSURE TIME OUT	Too long to reach a positive pressure set point.	Clean gasket and vessel, see section 11 ( <i>replace gasket after 500 cycles</i> ). Repeat the cycle. If the problem persists, call service.
4	FLUSH TIME OUT	Too long to flush the water out of the boiler/vessel	Repeat the cycle. If the problem persists, call service.
5	AIR BLEED TIME OUT	Too long for air bleed conditions to be complied with.	Repeat the cycle. If the problem persists, call service.
6	121/134 TIME OUT	Too long to reach sterilizing temperature.	Repeat the cycle. If the problem persists, call service.
7	VACUUM DRYING TIME OUT	Too long to reach vacuum set point in drying.	Clean gasket and vessel, see section 11 ( <i>replace gasket after 500 cycles</i> ). Repeat the cycle. If the problem persists, call service.
8	DRYING PRESSURE RISE TOO LONG	Too long to get back to atmospheric pressure in drying.	Repeat the cycle. If the problem persists, call service.
9	PRESS VS TEMP ERROR	Pressure and temperature do not meet steam table requirements.	Repeat the cycle. If the problem persists, call service.
10	RECOVERY TIME OUT	Too long to return to atmospheric conditions	Repeat the cycle. If the problem persists, call service.
11	OUT OF STERILIZING RANGE	Out of sterilizing range [121-125] or [134 to 138]	Repeat the cycle. If the problem persists, call service.
12	LAST CYCLE FAILED	Power failure/cycle interruption, the last cycle did not complete.	Turn munit off and allow to cool for 30 mins Repeat the cycle. If the problem persists, call service.
13	DOOR ERROR	The door micro-switch indicates a door open situation during a cycle.	Push the door shut & repeat the cycle. If the problem persists, call service.
14	PRE-STERILIZING ERROR	Steam check failed prior to sterilizing	Repeat the cycle. If the problem persists, call service.
15	ATMOSPHERIC PRESSURE ERROR	Atmospheric pressure not within specified range.	Repeat the cycle. If the problem persists, call service.
16	BOILER OVER TEMPERATURE	The thermistor has exceeded the maximum permitted level of 200°C:	Switch machine off and allow unit to cool for 1 hour before repeating the cycle. If the problem persists, call service.
17	USER ABORT	The cycle was aborted by the user before the cycle was completed.	Repeat the cycle with the same load
18	TEMP ALARM	The temperature on the PCB has gone out of limits.	Remove & check case fan filter - replace if excessively dirty. Repeat the cycle. If the problem persists, call service.
19	LEAK	A leak has been detected	Clean gasket and door. Repeat the cycle. If the problem persists, call service.
20	PRE-HEAT TIME OUT	The pre-heat time has taken too long.	Repeat the cycle. If the problem persists, call service.

As non-warranty related calls can be expensive it is advisable to ensure that all consumable items have been replaced or cleaned as appropriate, and that the water quality is as described in Section 26 before contacting Prestige Medical Ltd.

## Section 25: Cycle profiles

Please note all cycle times listed below and on the following page are approximate and will change depending on a number of external factors such as load type, load weight, room temperatures and machine switch on temperatures.

121°C Vacuum cycle profile

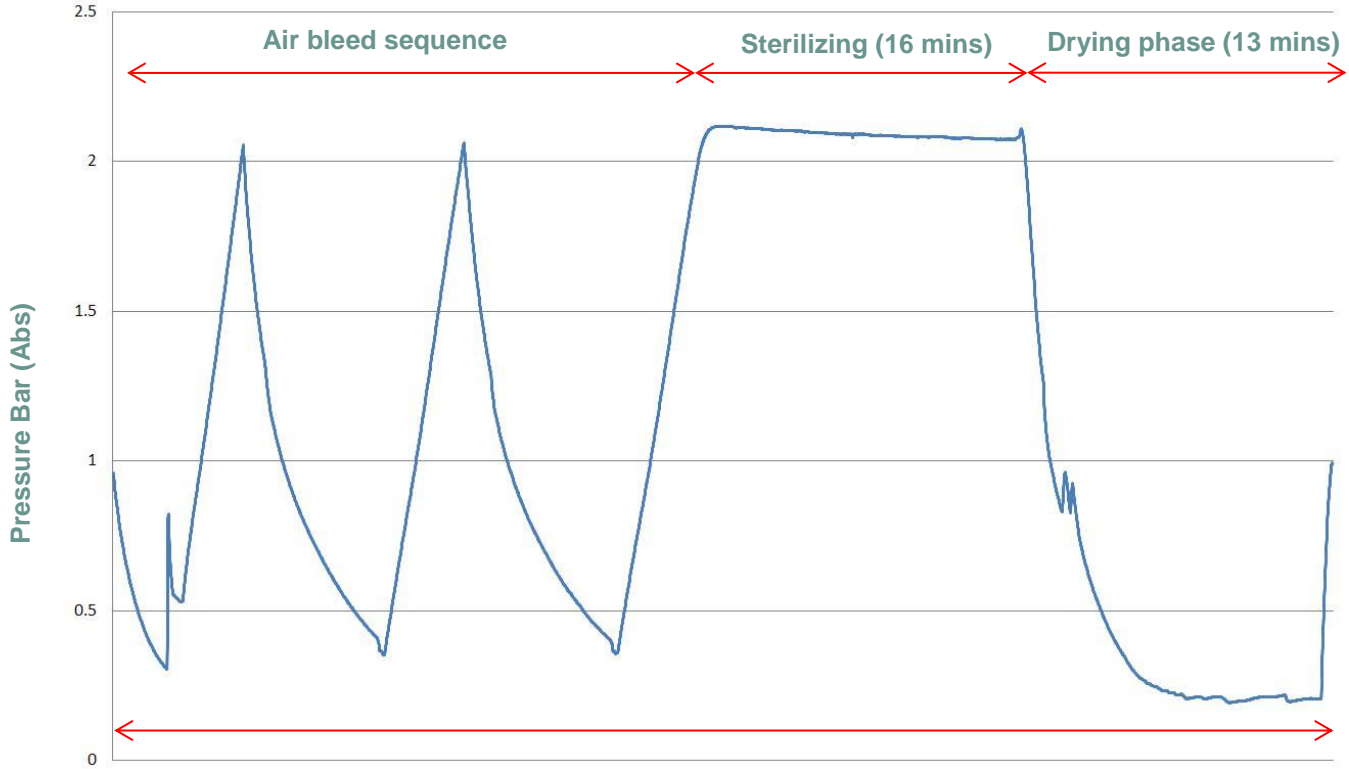

Cycle time - 51 mins  
(Approx.- based on 16 litre unit with a 2kg load)

134°C Vacuum cycle profile

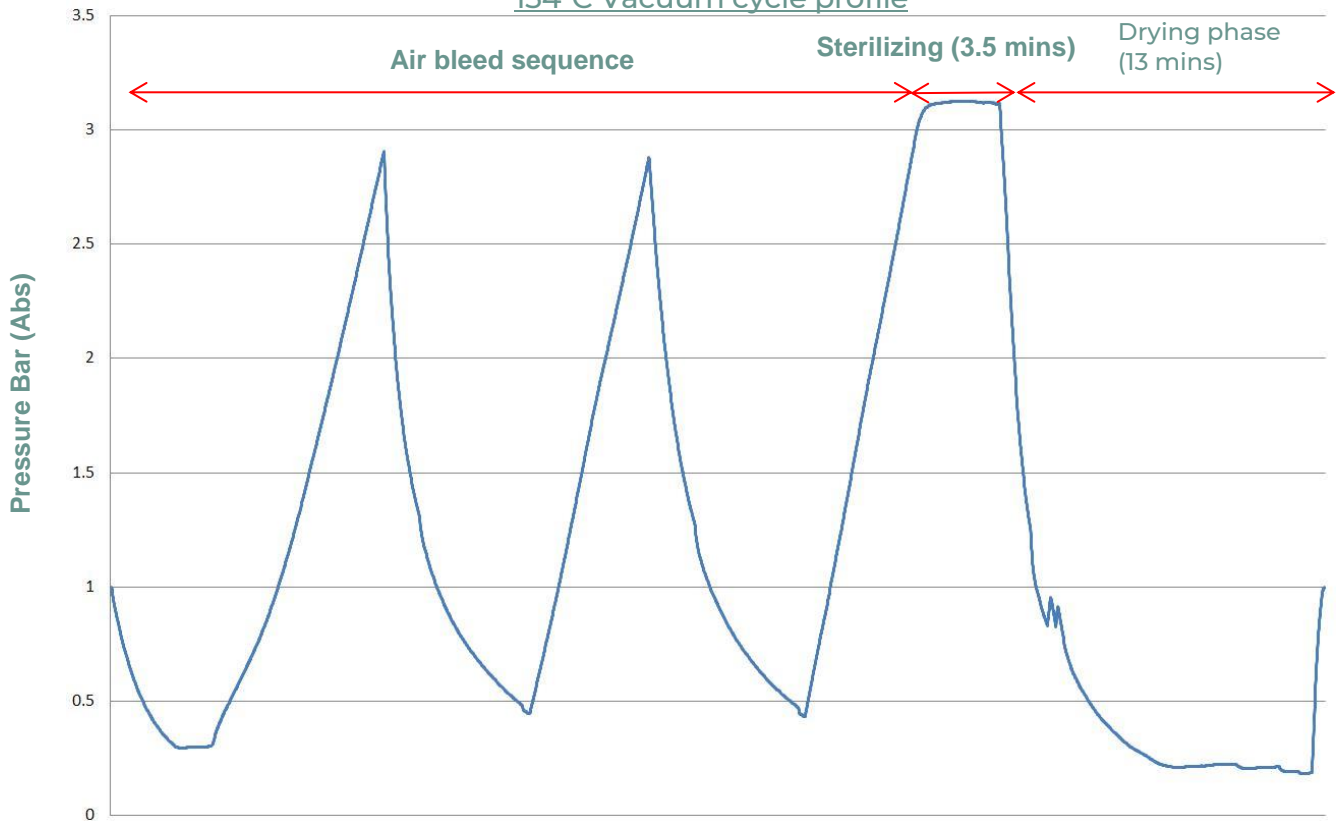

Cycle time - 39 mins  
(Approx.- based on 16 litre unit with a 2kg load)

### Prion cycle profile

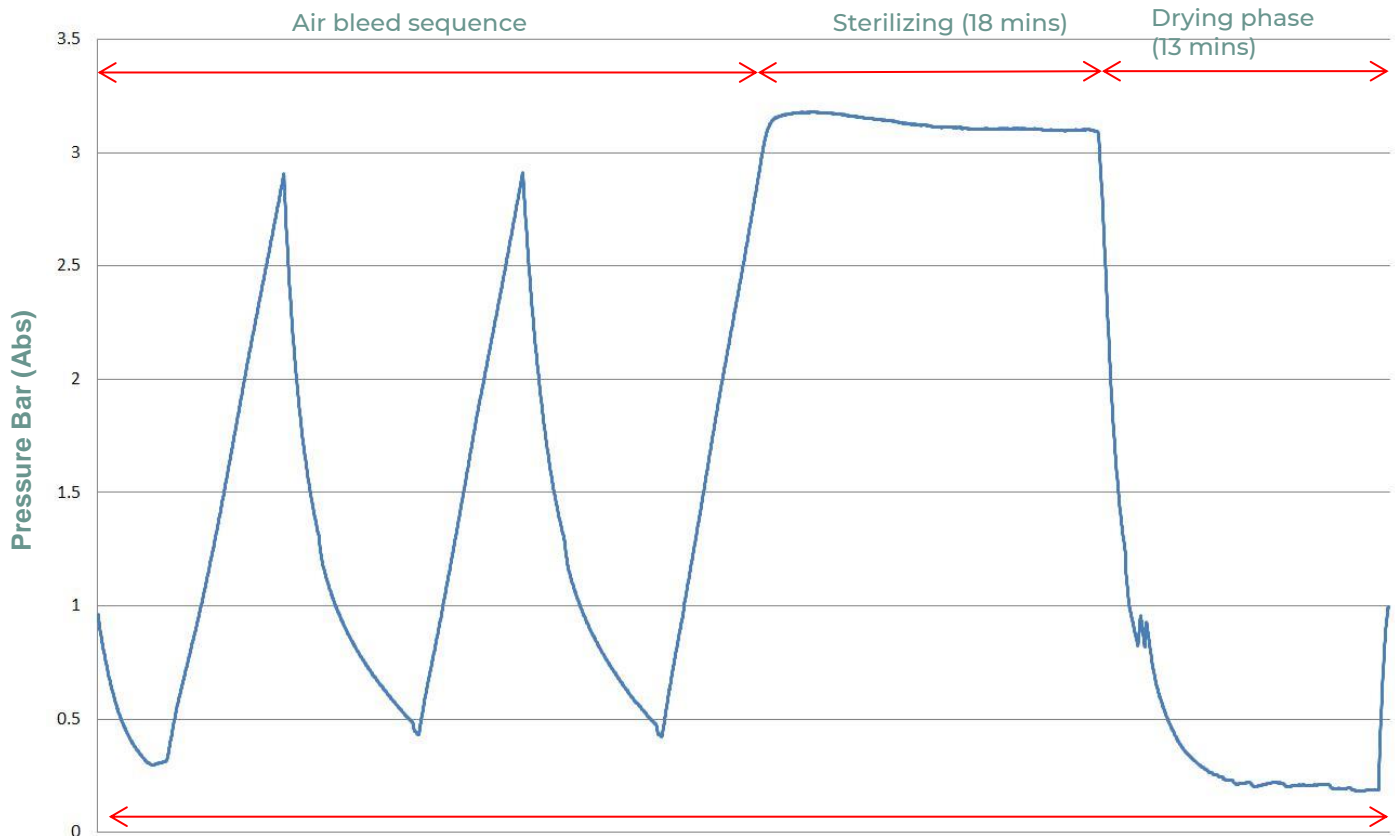

Cycle time – 54 mins  
(Approx- based on 16 litre unit with a 2kg load)

### 134°C PCD (Process challenge device)

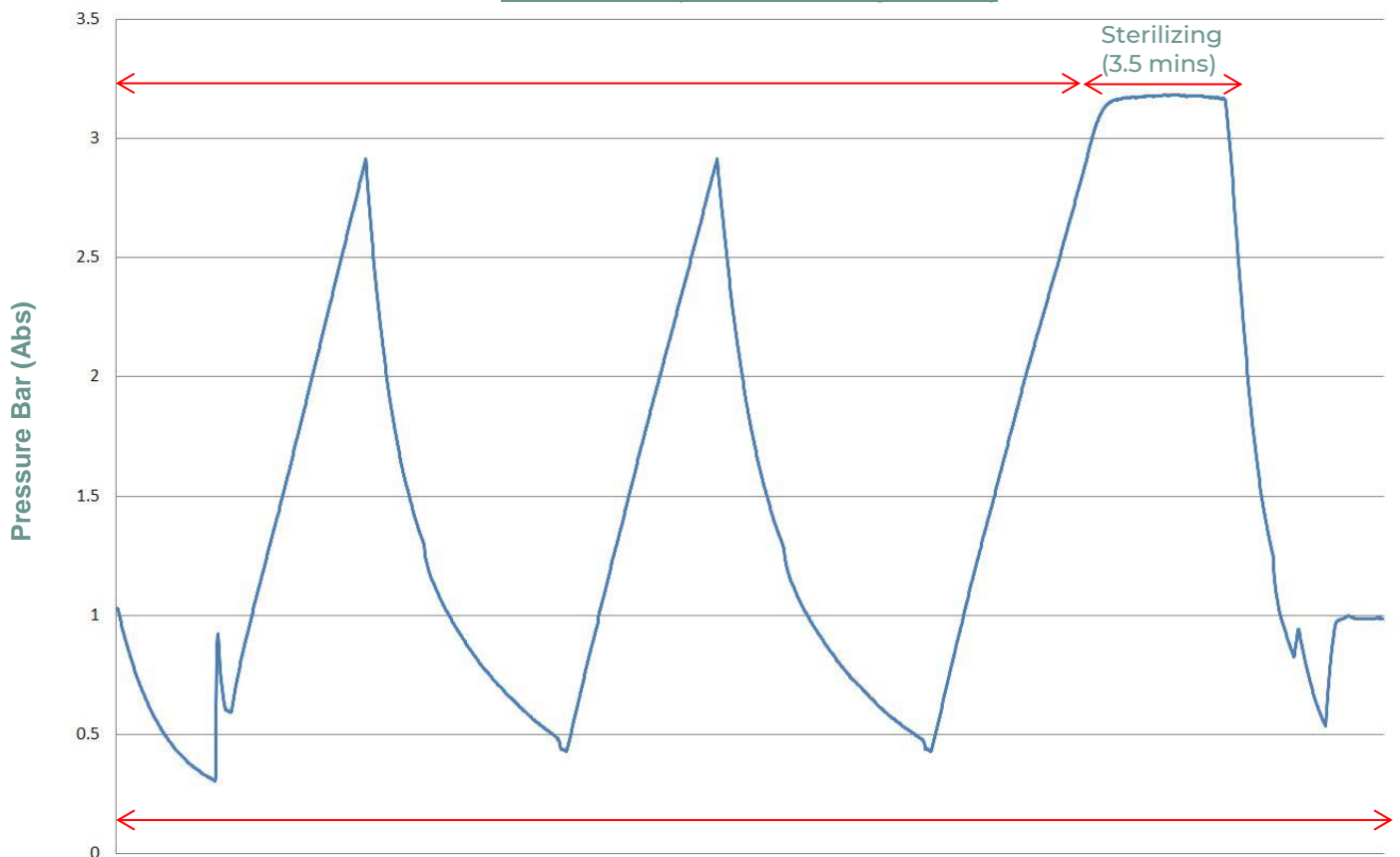

Cycle time – 27 mins  
(Approx- based on 16 litre unit with a no load)

121°C Non Vacuum cycle profile

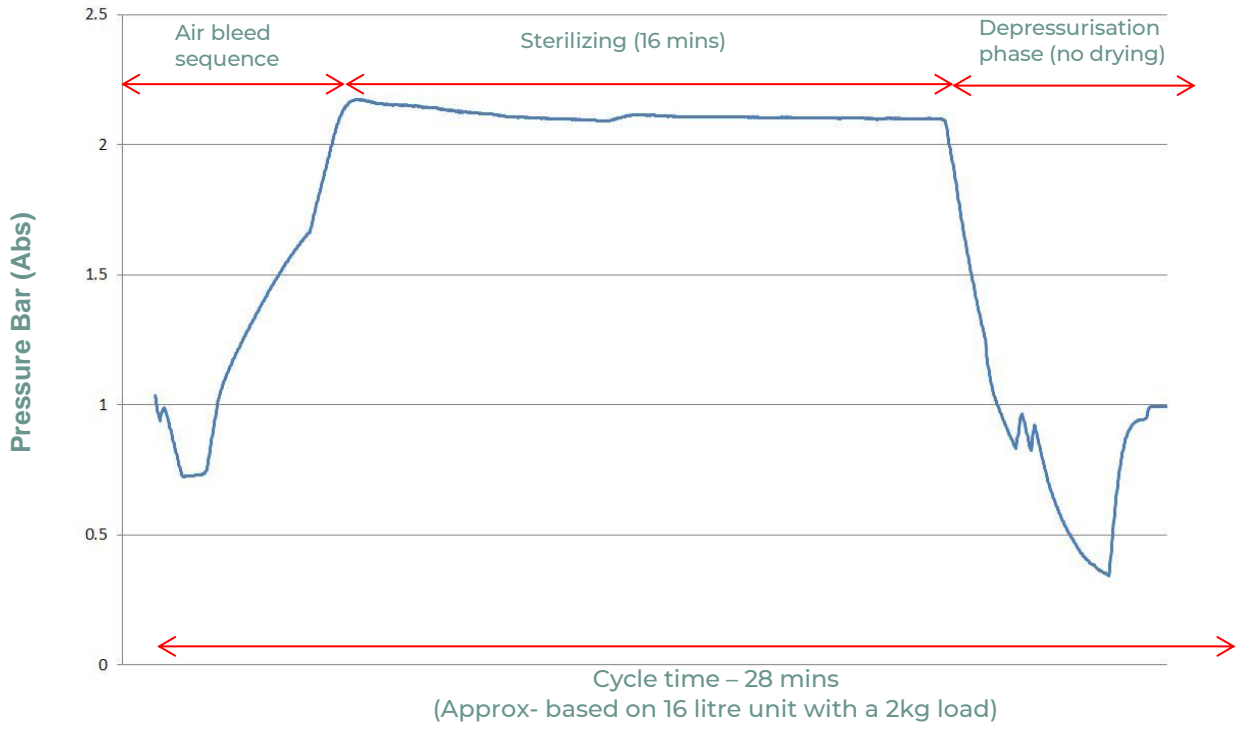

134°C Non Vacuum cycle profile

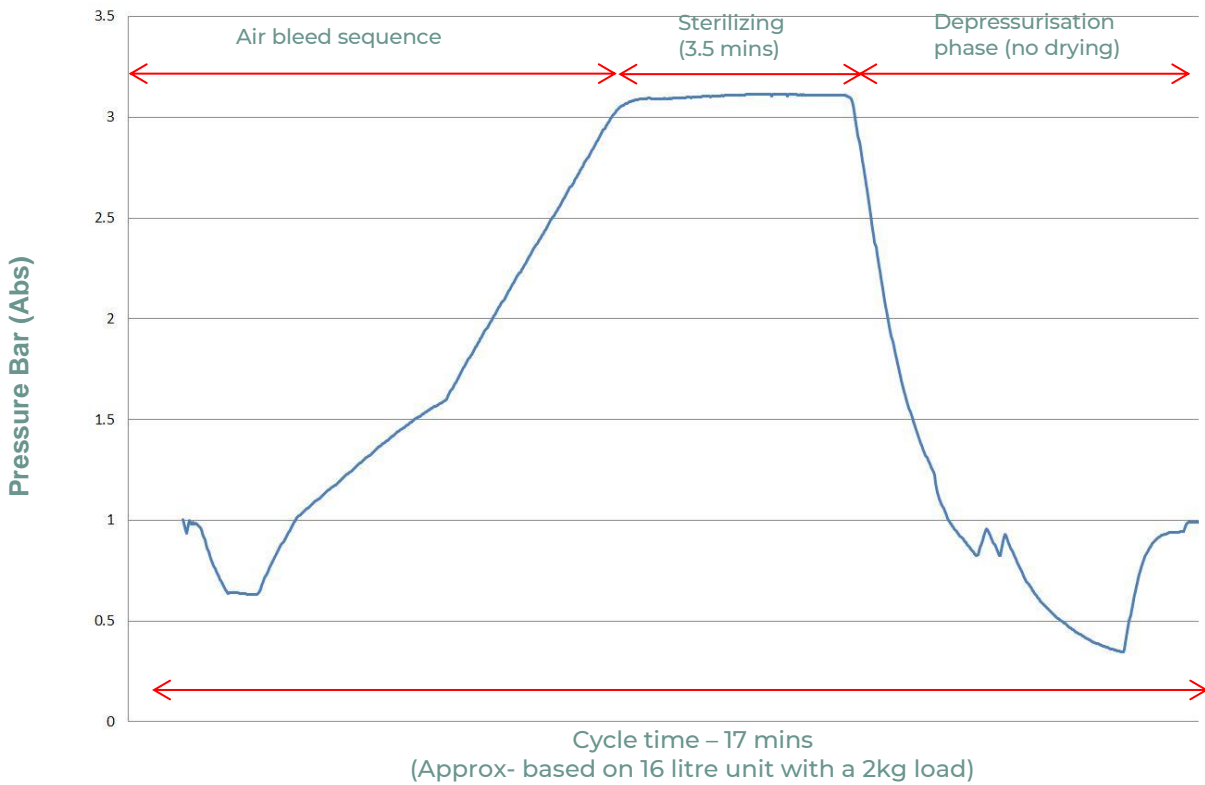

Cycle	Min Sterilizing Temp °C	Sterilizing Time (Mins)	16 litre cycle time	22 litre cycle time
134C Class B	134 °C	3.5 Minutes	39 Minutes	48 Minutes
121C Class B	121 °C	16 Minutes	51 Minutes	55 Minutes
PRION	134 °C	18 Minutes	54 Minutes	60 Minutes
PCD (Process Challenge Device)	134 °C	3.5 Minutes	26 Minutes	35 Minutes
134C Class N	134 °C	3.5 Minutes	17 Minutes	22 Minutes
121C Class N	121 °C	16 Minutes	28 Minutes	32 Minutes

## Section 26: Leak Test

Please use this test to validate the performance of the sterilizer in terms of leakage. During the test the following is checked:

- Efficiency of the vacuum pump.
- Tightness of the pneumatic circuit.

How to carry out the test:



Turn the machine on as instructed in section 8, then to select the Leak test continually press button B as shown in image 2, the display will cycle through the vacuum cycles. Once you have selected the Leak cycle as shown in image 3, please wait 2 seconds for the machine to switch to the main menu as shown below in image 4. Once the unit displays the main menu continue to press the start button as shown in image 5. The machine will then run the Leak test.



### WARNING!

When performing a Leak Test, the sterilizer chamber must be completely dry and cold. By not following this instruction, the Leak Test might fail even if the sterilizer works properly.

### Leak test failure:

If the unit fails a leak test (this will be displayed as "Leak test fail") please follow the gasket cleaning and maintenance instructions in section 11 of this user manual.

Once the maintenance of the gasket has been carried out as instructed in section 11 page 20, please proceed to repeat the Leak test.

If the unit fails a second leak test replace the door gasket with a new one and repeat the test. If the unit still fails the leak test then please contact the Prestige Medical UK Customer care centre for UK customers or for export customers please contact your local authorised dealer.

## Section 27: Water quality



Important: Please ensure that the correct water quality is utilised in all Prestige Medical autoclaves in order to prevent premature failure of the unit. Demineralised water must be utilised and have a water quality of less than 15µS (Microsiemens) or 10ppm (parts per million). The water quality should be checked on a daily basis utilising an appropriate TDS meter (total dissolved solids), a high quality TDS meter is available to purchase through your local dealer or directly from Prestige Medical.

Determinant	Value	Recommended test for compliance
Acid or Alkalinity	NQ	BP test. Tests for pH are not an acceptable substitute
Ammonium	0.2mg/litre	BP Test or other suitable method
Oxdisable substances	NQ	BP Test
Calcium and Magnesium	NQ	BP test. Tests for pH are not an acceptable substitute
Heavy Metals	0.1mg/litre	BP test. Tests for pH are not an acceptable substitute
Chloride	0.5mg/litre	BP Test or other suitable method
Nitrate	0.2mg/litre	BP Test or other suitable method
Sulphate	NQ	BP Test
Residue on evaporation	30mg/litre	BP Test. Conductivity measurement is not an acceptable substitute.
Pyrogens	0.25EU/ml	BP Test
<b>Based on EN 285:</b>		
Phosphate	0.1mg/litre	Any suitable method
Silicate	0.1mg/litre	Any suitable method
routine monitoring only:		
Electrical Conductivity	15µS/cm	

NQ = Not Quantified; BP = British Pharmacopeia; EU = Endotoxin unit. (Consideration should be given to single shot type sterilizers, where water is not returned to the reservoir at the end of the cycle).



**WARNING!**  
The manufacturer's warranty is void if the sterilizer was used with water containing contaminant or chemical levels exceeding those listed in the table above.

Aqua Pro – This water filtration system will supply de-mineralised water suitable for use with any Prestige Medical autoclave. Please refer to the Prestige Medical website for further details on this system.



Parts per million	Microsiemens
1 ppm	1.56 µS
2 ppm	3.12 µS
3 ppm	4.68 µS
4 ppm	6.24 µS
5 ppm	7.8 µS
6 ppm	9.36 µS
7 ppm	10.92 µS
8 ppm	12.48 µS
9 ppm	14.04 µS
10 ppm	15.6 µS



Water quality meter  
(Part No. 579007)

Aqua Pro water filtration system  
(Part No. 579033)

## Section 28: Accessories & consumables

Only those spare parts supplied or specified by Prestige Medical should be used in the maintenance of the autoclave. Use of unauthorised parts will invalidate any warranty and may adversely affect the performance or safety of the unit.



Cord set UK: (272100)  
Cord set EURO: (272099)



22 litre pouch tray  
(Part No. 309071)

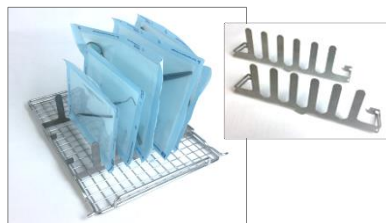

Vertical pouch rack kit (sold in pairs)  
Part No: 579006



Air filter (Part no.  
579034)



Set of 4 gaskets (Part  
number 579001)



Fan filter  
(Part Number: 579015)

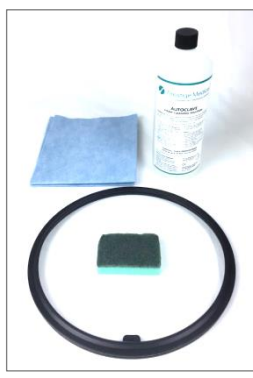

Autoclave cleaning kit.  
(Part no. 579005)



Printer rolls (Part  
No.279505): Ten  
replacement rolls.



Prestige Medical  
autoclave cleaning  
fluid (Part No.  
279493)



Printer UK (579023)  
Printer Euro (579024)

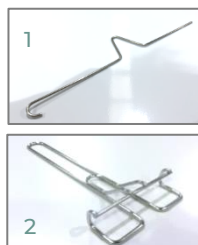

1/ Door tool (Part No.309068)  
2/ Tray lifter (Part No.279007)



Implant tray (Part No.579026)



Water quality  
meter (Part No.  
579007)



Helix Test Pack & 250 TST  
(Part No.579016)



TST strips  
(Part No. 259277)



Rapid Drain System  
(Part No. 579017)



Rear drain Kit  
6m (Part No. 579020)  
3m (Part No. 579019)



Std drain Kit  
(Part No. 579018)

 **MADE IN THE  
UNITED KINGDOM**



Prestige Medical Limited  
East House, Duttons Way,  
Shadsworth Business Park,  
Blackburn BB1 2QR, England

Registered in England  
Reg No. 2826793  
Vat No. 633707835

Registered Office:  
c/o United Cast Bar (UK) Limited,  
Spital Lane, Chesterfield,  
Derbyshire, S41 0EX, England  
Prestige Medical is a registered trademark



Paper



Please recycle